



# VLT<sup>®</sup> AutomationDrive Series

## Reliable. Efficient.

Engineered for design simplicity and high performance with a vast array of customized features, upgrades and options



100%

Full load tested

VLT<sup>®</sup> drives are factory tested insuring the highest level of quality and reliability.

# Modular design platform

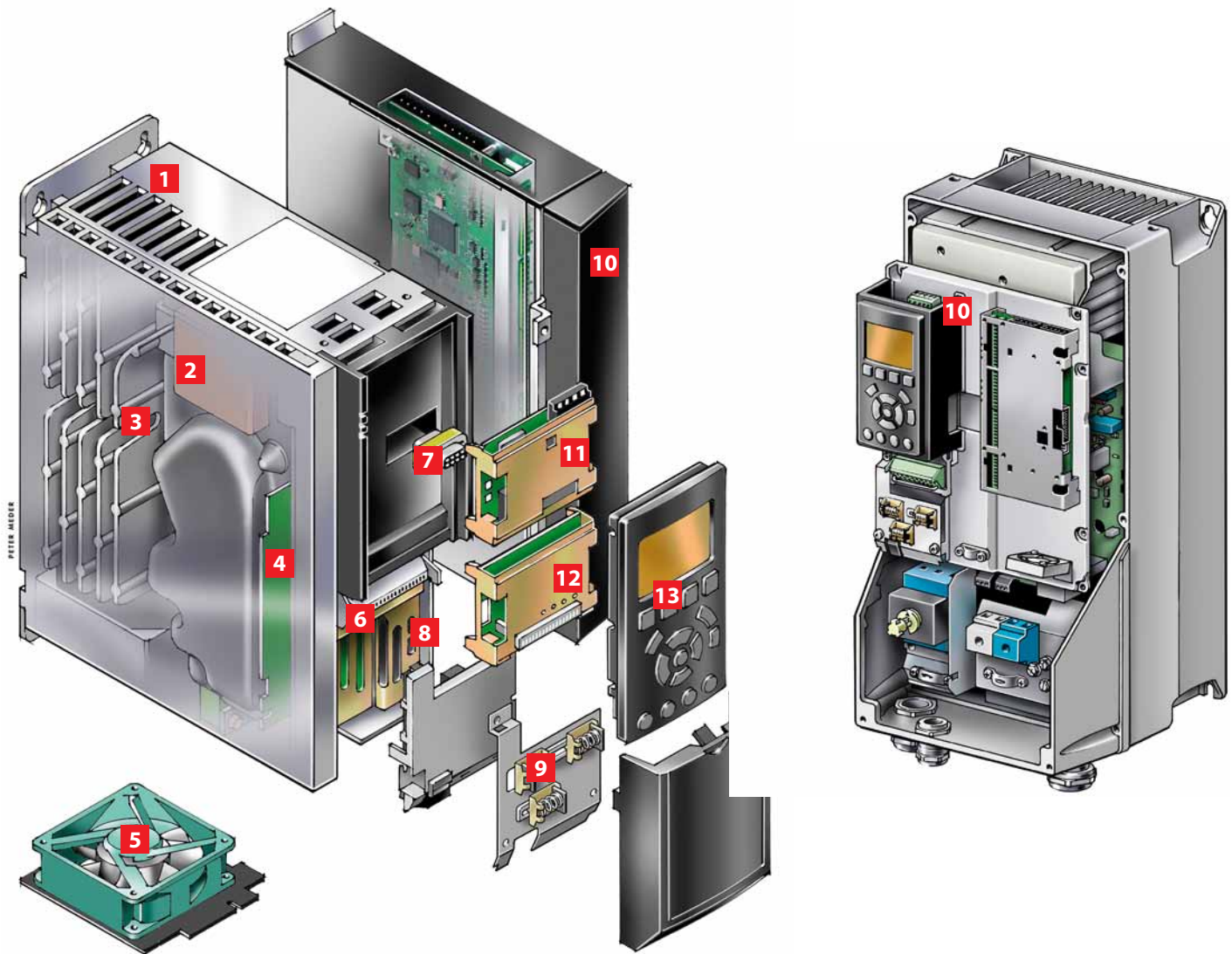

## 1 Enclosure

Meets requirements for enclosure class Protected Chassis (IP 20). Optional NEMA 1 (IP 21), NEMA 12 (IP 55), NEMA12 (IP 54) and NEMA 4X (IP 66) available.

## 2 DC coil

Built-in DC coil ensures very low harmonic disturbance of the power supply, in accordance with IEC-1000-3-2. Compact design means no need for external modules.

## 3 Cold plate technology

Built on a solid aluminum base that is integrated with the back panel to provide high mechanical stability, efficient cooling and the option of cold plate operation.

## 4 Conformal coating

Available with a coated circuit board that makes the drive perfect for operation in harsh environments.

## 5 Removable fan

The fan can be quickly removed and remounted for easy cleaning.

## 6 Safety

The VLT® AutomationDrive FC 302 comes standard with the Safe Stop functionality suitable for Category 3 installations in accordance with EN 954-1 is standard on the VLT AutomationDrive FC 302 and optional on the VLT AutomationVT Drive FC 322. This feature prevents the drive from starting unintentionally. Profisafe is available as an option.

## 7 Hot-pluggable LCP

The Local Control Panel (LCP) can be plugged in or unplugged during operation. Settings are easily transferred via the control panel from one drive to another or from a PC with MCT 10 setup software.

## 8 24 V

24 V supply keeps the VLT® AutomationDrive logic "alive" when the AC power supply is removed.

## 9 Control terminals

Specially developed spring-loaded cage clamps enhance reliability and facilitate easy commissioning and service. Optional screw terminals available.

# Save energy, space, time and costs

Danfoss' unequalled experience was used to make the VLT® AutomationDrive Series the perfect match for industrial applications. You will find our dedicated sales and service staff all over the world, 24 hours a day. With a wide range of powerful standard and optional features, the VLT AutomationDrive Series provides the lowest overall cost of ownership of any drive available.

## Save energy

- High efficiency (>98%)
- Sleep mode shuts off pumps when demand is low
- Automatic energy optimization produces typical savings of 3–5% (up to 15% possible)
- Flow compensation of setpoint
- Unique cooling concept

## Save space

- Compact, modular design
- Built-in DC-link reactors for harmonic suppression—no need for external AC input line reactors
- Optional, integrated RFI filters throughout the power range
- Integrated disconnects and fusing

*Energy savings using a VLT AutomationDrive are achieved with even a modest reduction in speed.*

## Save time

- Intuitive user interface with the new, award-winning local control panel (LCP)
- One drive type for the full power range
- Modular VLT design enables fast installation of options
- Automatic motor adaptation streamlines installation by automatically tuning the drive to the motor without spinning it or requiring the load to be decoupled
- Robust design and efficient monitoring significantly reduce maintenance requirements

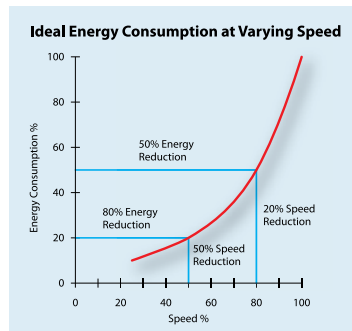

## Save costs

Protect your system with a series of pump-specific features:

- Cascade controller
- Dry pump detection
- End of curve detection
- Motor alternation
- 2-step ramps (initial ramp)
- Pipe fill mode
- Real-time clock
- Password protection
- Overload trip protection
- Smart logic controller
- User-selectable variable or constant torque operation
- NEMA/UL Type 12 (IP 54/55) and Nema 4X/IP66 enclosures can eliminate the need for separate panels

## 10 Advanced option

Free programmable MCO 305 Motion Controller with optional software for synchronizing, positioning and other advance applications using the VLT AutomationDrive FC 301 and FC 302.

Advanced Cascade control for up to 8 pumps available for VLT AutomationVT Drive FC 322.

## 11 Fieldbus option

Options for Fieldbus communication include Profibus, DeviceNet, CanOpen, Ethernet IP and Modbus TCP IP provide for tight system integration with a variety of industrial PLCs.

## 12 Application option

Optional cards expand system I/O capabilities by providing modules for:

- I/O Expansion
- Encoder or Resolver Inputs
- Additional Relays
- Safe PLC Interface
- Expanded Cascade Control
- Motor Thermistor Input

## 13 Display options

Input from our extensive user group significantly influenced the design and function of the new generation Local Control Panel (LCP). The removable LCP now comes with an improved user interface. Choose between six built-in

languages (including Chinese) or have it customized with any language you like. Two of the languages can be changed by the user.

The info button accesses virtually all information contained in the printed operation manual.

The Automatic Motor Adaptation (AMA), Quick Setup menu and large graphic display make commissioning and operation convenient and easy.

The LCP also comes with a choice of numerical display, graphical display or blind cover.

# VLT® AutomationDrive Series

## Just one drive to run a complete production line

The VLT® AutomationDrive series is a single drive concept that controls all operations from simple pump and fan to the most sophisticated motion control applications on any machine or production line. The standard versions cover a wide range of functions such as PLC functionality, automatic fine-tuning of motor control and self-analysis of performance.

Positioning, synchronizing, load estimation and even servo performance are also available.

All versions share an identical user interface, so once you've operated one, you can use them all.

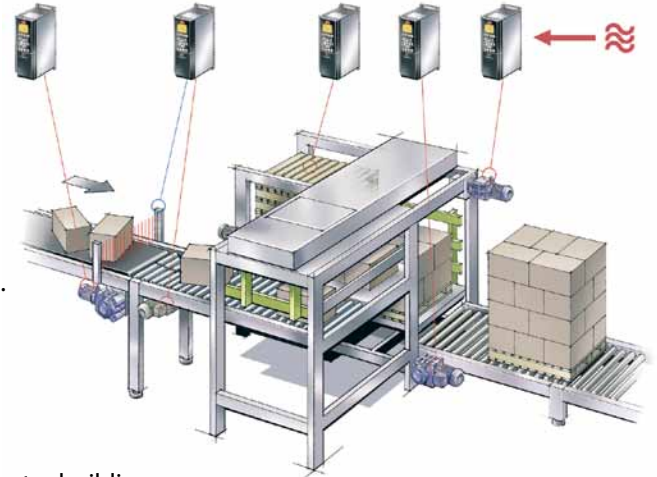

### Add flexibility to precision

The new VLT® AutomationDrive lets you alter production speed without rebuilding the conveyor. The Precise Pulse Stop feature ensures that products are always where they should be on the line.

### Accelerate or slow the entire line

Production speed can be changed at any time, even if the application involves several parts. The Precise Pulse Reference feature ensures that

all conveyors are in sync by designating a master conveyor, which all other conveyors follow.

#### Benefits:

- The conveyor can be stopped at a precise location using an open loop system independent of production speed.
- Precise Pulse Stop compensates for the speed of the object when it passes the stop sensor. This results in a precise stop, regardless of production speed.

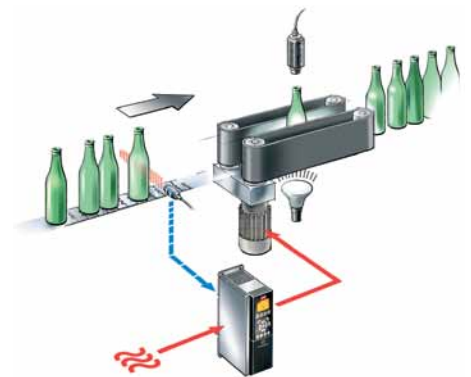

*The bottle is beneath the inspection camera at the exact moment the flash is activated. The VLT AutomationDrive ensures that production speed is adapted, even in complex operations along the entire production line.*

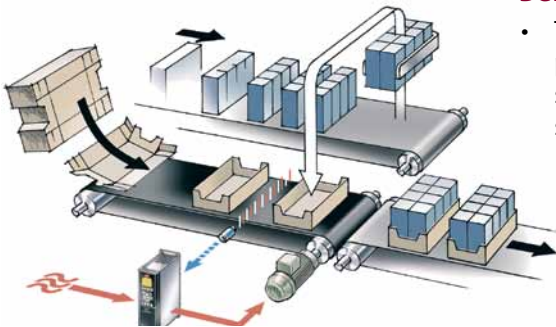

*Press, place, and release—that's all it takes for a reliable control cable connection that never needs servicing.*



*The VLT® AutomationDrive supports all PROFIdrive profiles for automation.*



*The fan is easily removed for cleaning of the heatsink.*

## Built-in Smart Logic Controller

The smart logic controller is a simple way to keep your drive, motor and application working together. The controller is programmed to monitor a specific process event. When the monitored event occurs a specific action can be programmed to execute. Up to 20 different events can be monitored before looping back to step one.

The smart logic controller is able to monitor any parameter that can be defined in either a "true" or "false" state.

This includes not only digital commands, but also logic expressions,

allowing even sensor outputs to influence the operation. Temperature, pressure, flow, time, load, frequency, voltage and other parameters combined with the arithmetic comparators like ">","<","=", logic operations like "or", "and", "not", along with timer and counter functions allow the installer to form a series of logical statements that greatly integrates the drive into the manufacturing process.

That's why Danfoss calls it a "logic" controller; because you can program the controller to react to almost any event you choose.

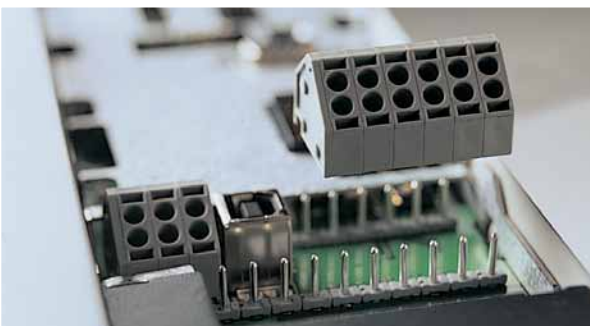
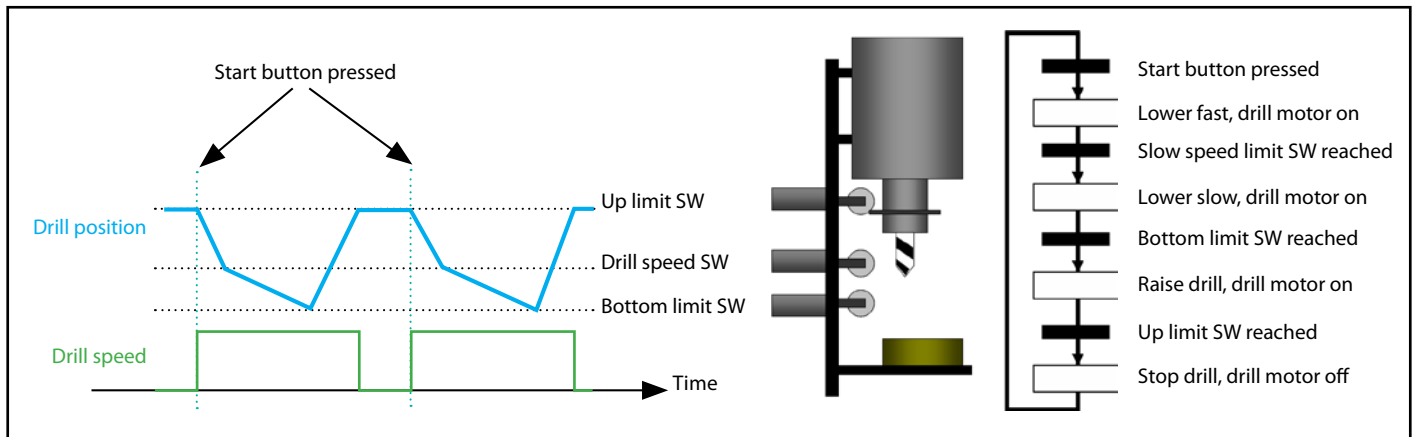
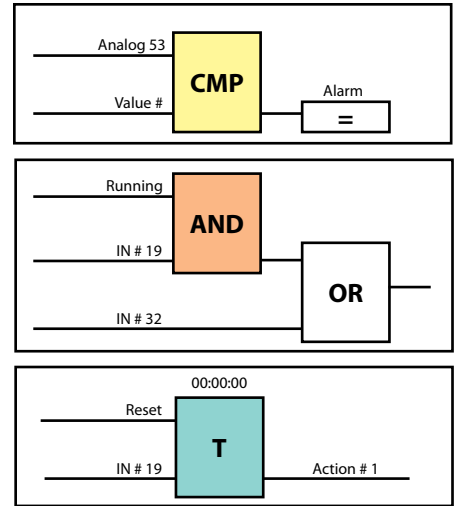

To disconnect wires, simply unplug the terminal blocks.



Plug-and-play is the way with the Automation Drive. Even the power supply, sensor cables and looping connections are convenient plugs.



The fieldbus option plugs in beneath the front panel. It can be turned upside down to allow for cable entry on top.

# Intelligent heat management

## Two cooling methods for different needs

Total separation between cooling air and electronics allows for solutions where heat is removed outside cabinets.

With VLT® AutomationDrive Series, a flanged heatsink kit is available for mounting the drive in the backplate of a cabinet.

### Forced convection cooling

A fan blows cold air through the cooling ribs of the aluminum base. The channel is easily cleaned without touching electronics.

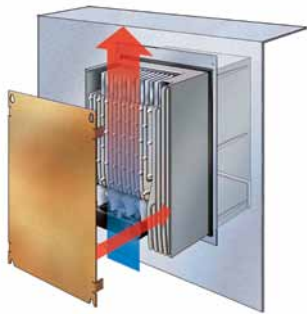

Flanged heatsink

### Cold plate cooling

External cooling is possible through the back side of the aluminum base.

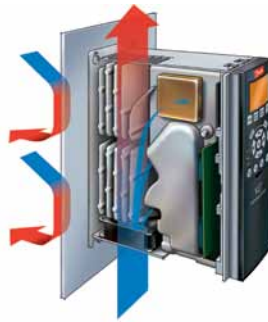

Wall mounted with forced cooling through the heatsink.



A smart, dedicated kit allows D1 and D2 enclosures to be mounted in Rittal cabinets so cool air removes 85% of excess heat without contact to the electronics.

## VLT® MCO 305 Motion Controller

The MCO 305 is an integrated Motion Controller that can be provided with embedded firmware for simple synchronizing, positioning, and center winding applications. Integrating this option into the VLT AutomationDrive

FC 301 or FC 302 transforms the drive into a highly intelligent system providing accurate dynamic motion control for the most sophisticated applications.

The MCO 305 option utilizing the MCT 10 programming tools provides complete programming capabilities allowing the user to completely customize the VLT AutomationDrive for the most demanding applications.



DC coils reduce harmonic noise and protect the drive.

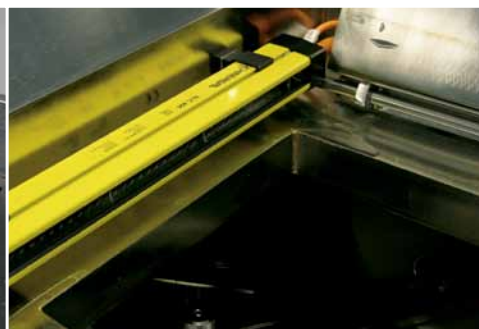

Safety installations can be connected directly to the VLT® AutomationDrive.



Cold plate.

# Award-winning, user-friendly interface



## 1 Graphical display

- Informative overview
- Six lines of display
- Graphical or numerical display of information
- Readout in user-selectable engineering units
- Select from up to 27 languages as standard
- Backlit for increased visibility

## 2 Quick Menus

- Danfoss-defined Quick Menu
- My Personal Menu allows users to define their own menus of commonly accessed parameters

- Changes Made Menu displays the parameters to which changes have been made
- Function Setup Menu provides quick setup for specific applications
- Logging Menu provides access to operation history

## 3 Illumination

- Illuminated LEDs indicate which function is active

## 4 Menu structure

- Based on the field-proven matrix system used in previous VLT® Series drives
- Menu shortcuts access specific functions
- Edit and operate in different setups simultaneously

## 5 Other benefits

- The keypad is removable during operation
- Upload/download setups between drives using the keypad
- Remote mounting kit available for panel installation
- Hand / off / auto buttons for easy switching between manual and automatic control

## 6 Additional buttons

- Info: an “onboard manual” that provides specific information about each parameter
- Cancel: exits current parameter without saving changes
- Alarm log: easy access to a list of all previous alarm conditions

The VLT® AutomationDrive has an award-winning Local Control Panel (LCP) that was designed based on user feedback.

With a well-structured menu system, the VLT® AutomationDrive ensures fast commissioning and easy access to its many powerful functions.



# Built for a variety of applications

## with a wide range of advanced features

### Quicker handling of small loads

Equipment is typically sized to handle a maximum load, and speed is usually determined by this maximum load.

The ability to change speed automatically allows equipment to operate at a partial or minimum load. The drive estimates the load and maximizes production speed.

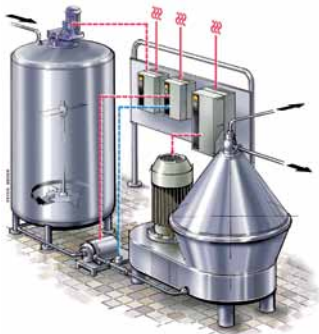

### NEMA 4X (IP 66) for harsh environments

All VLT® AutomationDrives have manganic phosphor rear bodies. The backs of NEMA 4X (IP 66) enclosures are dip-coated with epoxy or polyester spray finish (60–100 µm). The cover is powder coated (80–100 µm).

The silicone gasket is tested with various detergents.

### Reliable, accurate load handling

Changing conditions influence the operation of cranes and other equipment. Depending on position and load, a crane tends to shake when stopping or starting, because it's calibrated to an average load.

The VLT® AutomationDrive estimates motor currents generated by actual loads and compensates to make the crane start and stop smoothly just where it should. The same benefits apply to hoists and elevators.

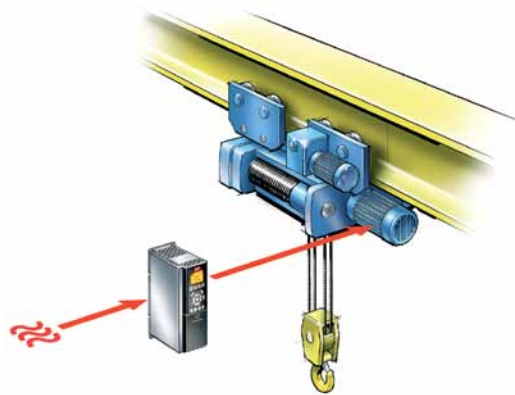

### Small footprint

Throughout the entire power range, all sizes of VLT® AutomationDrives are even smaller than comparable previous drives. No dimension has increased, and volumes are typically 20% smaller.

### Gentle on goods—and brakes

When stopped, the AutomationDrive will slow a hoist to zero before activating the mechanical brake. This results in gentler handling, and virtually eliminates wear on the brake.

#### Benefits:

- Low torque ripple gives smooth operation
- Precise load estimation allows for precise positioning regardless of load
- Load estimation saves time and speeds up production safely and intelligently
- Full holding torque capability at 0 RPM gives a smooth ride and reduces mechanical wear on gears and brakes, minimizing maintenance and maximizing production up-time



The VLT® AutomationDrive provides crane and hoist applications with smooth, precise operation while reducing wear and tear on driven equipment.



Coated control boards are available for harsh environments.

## One-wire safety

The VLT® AutomationDrive FC 302 and the VLT® AutomationVT Drive (optionally) are equipped with with safe stop functionality suitable for category 3 installations as defined by EN 954-1. This standard feature prevents a drive from starting accidentally. The safe stop terminal can be used to “safe coast” the motor - the stop function satisfies stop category 3 EN 60204-1.

Expensive and bulky external components can be omitted, wiring simplified, and downtime minimized with this solution. The safety signals can be transferred via discrete signals wiring (in compact machinery) or safe bus communication (in extended manufacturing plants).



Since it's approved for safety category 3 applications, the VLT® AutomationDrive and AutomationVT Drive is a perfect match for the Pilz safety relay. The electrical connection is extremely simple—just one wire.

The VLT® AutomationDrive and AutomationVT Drive is approved for providing safe stop in category 3 installations without the need for feedback signals from the drive to the safety relay.

## 600 & 690 V

Both the VLT AutomationDrive and VLT AutomationVT Drive can be ordered for either 575 volt or 690 volt applications found in the petrochemical, gas supply, mining and forestry markets. The 690 volt version is available to 1.4 MW of power.

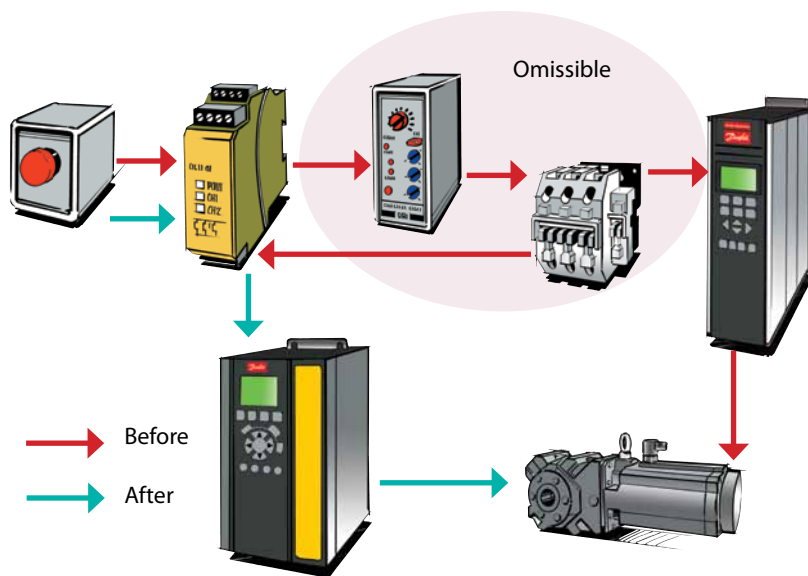

## When torque is the issue

In all winders, the torque required to accelerate and decelerate an application varies with the load. With center winders the required torque even varies with the dimension of the roll. Torque mode with high-precision torque control is needed.

It is essential in winding operations to fully control the tension of the material being wound. To maintain tangential tension independently of the line speed and roll diameter, the drive is able to dynamically follow a wide range of torque references.

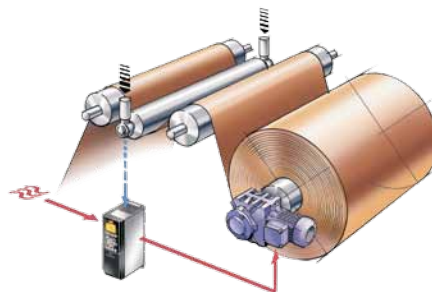

# Designed with the user in mind

## The VLT® AutomationDrive maximizes system reliability with built-in protection:

- System overloads
- Motor failures
- Motor and drive overheating
- Voltage disturbances
- Power surges
- Loss of phase
- Phase-to-phase and phase-to-ground short circuit
- Ground fault
- Switching on input/output
- Electrical disturbances
- Overvoltage
- Overcurrent
- Undervoltage
- External fault
- Overtemperature

## Minimize motor noise and heating with ASFM

With the ASFM (Adjustable Switching Frequency Modulation) function, the switching frequency is adjusted automatically in relation to the speed of the motor. As speed is reduced, the switching frequency increases to ensure optimally low motor noise and reduce motor heating.

## Output protection for longer motor life

VLT® AutomationDrives incorporate both DC-link reactors and motor output protection as standard design features. This provides short circuit protection and allows unlimited switching on the output without damage to the drive, eliminating the need for additional output reactors or switch interlocks.

The DC-link reactors improve overall efficiency by increasing the power factor and lowering the ripple current in the bus voltage providing an almost threefold increase in capacitor and drive life. As a result, motor operation is smooth and quiet and longer motor life can be expected.

Hall effect current transducers measure current flowing on all three motor phases. This provides highly responsive and accurate feedback to the VLT control circuit for optimum motor protection and performance.

## Cascade Controllers

Provide additional relays for staging of additional pumps:

- MCO 101 extended cascade controller controls up to five pumps
- MCO 102 advanced cascade controller controls up to eight pumps

Cascade controller option cards extend the capabilities of the VLT® AutomationVT Drive FC 322, allowing the control of up to eight parallel pumps configured to appear to the system as a single larger pump. Individual pumps are automatically turned on (staged) and turned off (destaged) as needed to satisfy the required system output for flow or pressure. The speed of the pumps is also controlled to provide a continuous range of system output.

Available as a factory-installed option or a field-installed accessory, cascade controller option cards provide constant pressure or level control while reducing water hammer and energy consumption. They also eliminate the need for PLCs and external controllers.

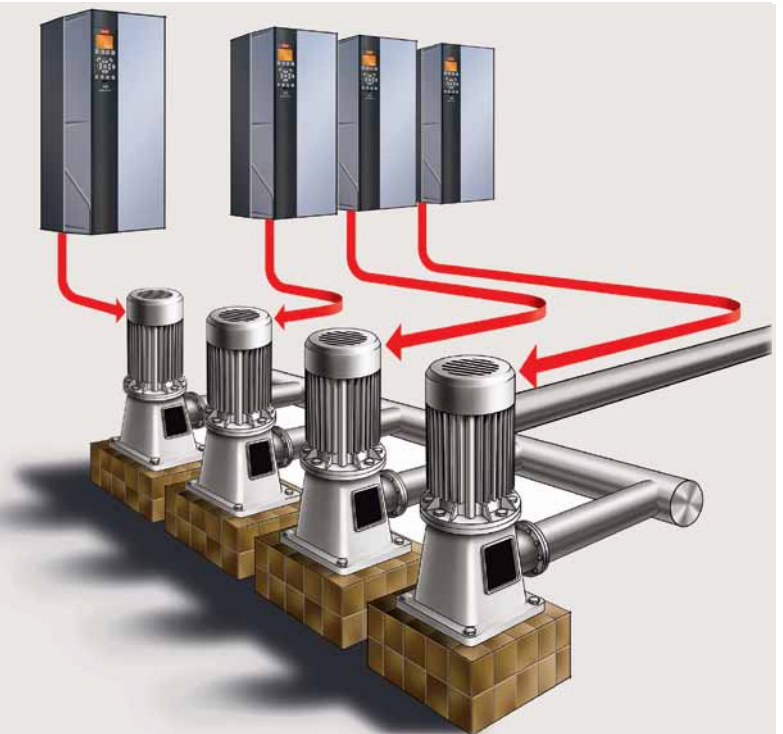

*A typical AutomationVT Drive FC 322 installation utilizing the Cascade Controller option in conjunction with three additional AutomationVT Drives FC 322 to operate one to four pumps as demand requires.*

## VVC<sup>PLUS</sup> output switching pattern

Unique digital VVC<sup>PLUS</sup> voltage vector control provides:

- A nearly perfect output sine wave that reduces the overshooting and undershooting of voltage and current generated by standard PWM drives
- Fully rated motor voltage at rated frequency
- Increased efficiency for both drive and motor
- Full motor performance without derating; no additional heating of motor windings
- Motor cable lengths up to 1000' standard

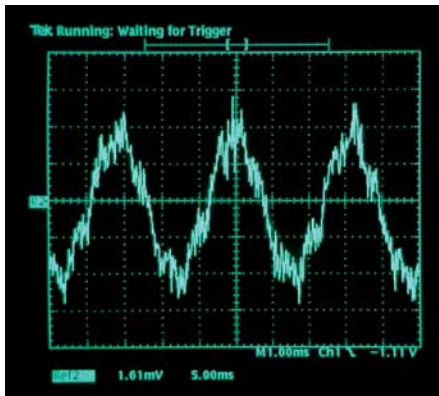

Brand "X" PWM scope trace (top) compared to smoother VVC<sup>PLUS</sup> scope trace (bottom).

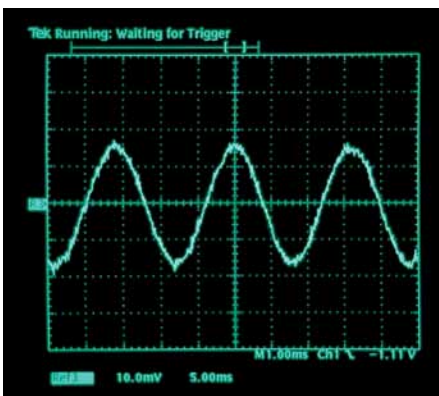

## Reduced installation cost

Dual DC-link reactors reduce the input RMS current to less than or equal to the output current. This greatly reduces the cable size requirement and the subsequent cost of installation.

## Minimal harmonic distortion/ maximum power factor

DC-link reactors reduce the harmonic distortion currents that a variable frequency drive injects back into the AC line. The properly sized reactors in a VLT AutomationDrive can reduce line harmonic currents by up to 40% of the fundamental current. This eliminates the need and cost of additional AC line reactors and their resultant line voltage reduction.

## Thermal protection for the drive and motor

The ETR (Electronic Thermal Relay) is an open loop method built into the VLT AutomationDrive software to guard against motor overheating, requiring no additional sensors or wiring. This function is UL recognized (Class 20) as an effective guard against motor thermal overload.

The VLT AutomationDrive has built-in thermal protection and also accepts thermistor signal input from the motor to create closed loop thermal protection for the entire system.

## Input line protection from extreme running conditions

### Short circuit

The VLT AutomationDrive incorporates 3 hall effect sensors, one in each of the three motor phases to protect against short circuits. A short circuit between two output phases (or to ground) will shut down the drive as soon as the current exceeds the maximum value.

### Line disturbances and transients

To protect itself from AC line voltage disturbances, the drive monitors all three phases and interrupts drive operation in the event of phase loss or imbalance. Transients on the AC line are suppressed by MOVs as well as zener diodes for extreme transients. Danfoss VLT AutomationDrives meet VDE 0160 (European standard—2.3 x line voltage for 1.3 msec) for transient protection.

### Voltage sags and surges

The VLT AutomationDrive is designed for a wide range of operating conditions. The 480 volt drive will operate from 342–528 VAC. The 230 volt drives will operate on 180–264 VAC. 575 volt drives will operate on 495–660 VAC and 690 volt drives will operate on 472–759 VAC. Full rated motor voltage and torque can be delivered with voltage dips down to 10% under nominal AC line voltage. During an AC line drop-out, the VLT AutomationDrive continues until the intermediate circuit voltage drops below the minimum stop level, which is typically 15% below the VLT AutomationDrive's lowest rated supply voltage.

### Ground fault

The VLT AutomationDrive provides complete protection from potentially damaging ground fault conditions on both the supply side and the motor side.

# One drive. Three performance levels.

	FC 301	FC 302	FC 322
<b>Operating</b>			
Power Range 200-240 Vac [HP]	1/3 to 50	1/3 to 50	1/3 to 60
Power Range 380-480 Vac [HP]	1/2 to 100	na	1/2 to 1350
Power Range 380-500 Vac [HP]	na	1/2 to 1200	na
Power Range 525-600 Vac [HP]	na	1 to 100	1 to 125
Power Range 525-690 Vac [KW]	na	11 to 1000	11 to 1200
Ambient Temperature C (average for 24 hours without de-rating)	50	50	50
Ambient Temperature with de-rating	55	55	55
Variable Switching Frequency 1-16 KHz	√	√	√
<b>Cable Length</b>			
Shielded/Unshielded	50/75 m	150/300 m	150/300 m
RFI EN55011 class A2 industry	<5 m	<5 m	<5 m
RFI EN55011 class A1 industry	<50 m	<150 m	<150 m
RFI EN55011 class B domestic	<10 m	<50 m	<50 m
<b>Control Modes</b>			
Voltage Vector Control (VVC+)	√	√	√
Flux Vector Control	na	√	na
Permanent Magnet Motor	na	√	na
Automatic Energy Optimization (AEO)	√	√	√
Flying Start	na	√	√
Over Voltage Control (OVC)	√	√	√
Controlled Ramps	√	√	√
Linear & S Ramps	√	√	√
Process PID Control	√	√	√
Precise Start/Stop	√	√	√
Digital Potentiometer	√	√	na
Preset References	√	√	√
<b>Enclosure Styles</b>			
Chassis (IP00)	√	√	√
Protected Chassis (IP20)	√	√	√
NEMA 1 (IP21)	√	√	√
NEMA 12 (IP55/54)	√	√	√
NEMA 4X Indoor (IP66)	√	√	√
<b>Special Functions</b>			
Smart Logic Controller	√	√	√
Logic Rule Control	√	√	√
Safe Stop Functionality (EN 954-1 cat 3)	na	std	opt
Real Time Clock	na	na	√
Automatic Motor Adaptation	√	√	√

	FC 301	FC 302	FC 322
<b>Interface</b>			
Numeric Keypad	opt	opt	opt
Graphical Keypad	std	std	std
Info/Help Function	√	√	√
Personal Menu	√	√	√
Regional Settings	√	√	√
Multi-Lingual Support	√	√	√
Change made Restore Previous Setting	√	√	√
Password Protection	√	√	√
<b>Std Input/Output</b>			
Analog Inputs	2	2	2
Analog Outputs	1	1	1
Digital Inputs	5	6	6
Digital Ouptuts	1	2	2
Relay Outputs	1	2	2
<b>Communications</b>			
RS-485 (built in) protocol (built in)	√	√	√
	Modbus RTU or FC Protocol		
USB Port (built in)	√	√	√
Optional Profibus	√	√	√
Optional DeviceNet	√	√	√
Optional CanOpen	√	√	na
Optional Ethernet	√	√	√
Optional Modbus TCP/IP	√	√	√
<b>I/O Expansion</b>			
Analog Inputs	2	2	3
Analog Outputs	1	1	3
Digital Inputs	3	3	3
Digital Ouptuts	2	2	2
Relay Outputs	3	3	3
Encoder	1	1	na
Resolver	1	1	na
Safe PLC Interface	na	1	na
Thermistor Input	na	√	√
Extended Cascade Control	na	na	√
<b>Other Functions</b>			
Advanced Cascade Control	na	na	√
Programmable Motion Control	√	√	na
Positioning Control	√	√	na
Synchronizing Control	√	√	na
Center Winding Control	√	√	na
SALT	na	√	na

# Enclosures

Broad Range of Protection Classes

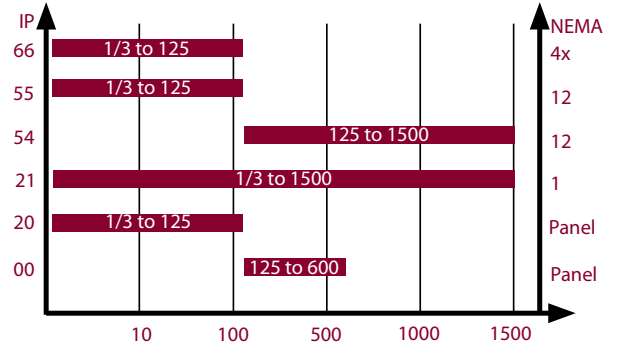

## Cabinet sizes

Dimensions shown in inches.

### Chassis (IP20, IP00)

Frame Size	A1	A2	A3	B3	B4	C3	C4	D3	D3H	D4	D4H	E2
Height	7.9	10.6	10.6	16.5	23.7	25.0	31.7	39.3	33.3	50.3	41.3	59.0
Width	3.0	3.5	5.1	6.5	9.1	12.1	14.6	16.1	9.8	16.1	13.8	23.0
Depth	8.1	8.1	8.1	9.8	9.5	13.1	13.1	14.7	14.8	14.7	14.8	19.4

### NEMA 1, NEMA 12, NEMA 4X Indoor (IP21, IP55, IP54, IP66)

Frame Size	A2	A3	A4	A5	B1	B2	C1	C2	D1	D1H	D2	D2H	E1	F1	F3
Height	14.6	14.6	15.4	16.5	18.9	25.6	26.8	30.3	45.6	33.7	60.6	41.7	78.7	89.8	89.8
Width	3.5	5.1	7.9	9.5	9.5	9.5	12.1	14.6	16.5	12.795	16.5	16.5	23.6	55.1	78.6
Depth	8.1	8.1	7.0	7.9	10.3	10.3	12.2	13.2	14.7	14.9	14.7	14.9	19.4	23.9	23.9

# Current and power by enclosure size

	3 Phase 200-230 Vac						3 Phase 380-480 Vac (FC 322 & FC 301) 380-500 Vac (FC 302 only)					
	NO 110% (FC 322)			HO 160% (FC 301 & FC 302)			NO 110% (FC 322)			HO 160% (FC 301 & FC 302)		
	Output Current Amps	Shaft Output		Output Current Amps	Shaft Output		Output Current Amps (480 V)	Shaft Output		Output Current Amps (480 V)	Shaft Output	
	KW	HP		KW	HP		KW	HP		KW	HP	
PK25	1.8	0.25	1/3	1.8	0.25	1/3						
PK37	2.4	0.37	1/2	2.4	0.37	1/2	1.2	0.37	1/2	1.2	0.37	1/2
PK55	3.5	0.55	3/4	3.5	0.55	3/4	1.6	0.55	3/4	1.6	0.55	3/4
PK75	4.6	0.75	1	4.6	0.75	1	2.1	0.75	1	2.1	0.75	1
P1K1	6.6	1.1	1-1/2	6.6	1.1	1-1/2	2.7	1.1	1-1/2	2.7	1.1	1-1/2
P1K5	7.5	1.5	2	7.5	1.5	2	3.4	1.5	2	3.4	1.5	2
P2K2	10.6	2.2	3	10.6	2.2	3	4.8	2.2	3	4.8	2.2	3
P3K0	12.5	3.0	4	12.5	3.0	4	6.3	3.0	4	6.3	3.0	4
P3K7	16.7	3.7	5	16.7	3.7	5						
P4K0							8.2	4.0	5	8.2	4.0	5
P5K5	24.2	5.5	7-1/2	24.2	5.5	7-1/2	11.0	5.5	7-1/2	11.0	5.5	7-1/2
P7K5	30.8	7.5	10	30.8	7.5	10	14.5	7.5	10	14.5	7.5	10
P11K	46.2	11.0	15	46.2	11.0	15	21.0	11.0	15	21.0	11.0	15
P15K	59.4	15.0	20	59.4	15.0	20	27.0	15.0	20	27.0	15.0	20
P18K	74.8	18.5	25	74.8	18.5	25	34.0	18.5	25	34.0	18.5	25
P22K	88.0	22.0	30	88.0	22.0	30	41.0	22.0	30	41.0	22.0	30
P30K	115.0	30.0	40	115.0	30.0	40	52.0	30.0	40	52.0	30.0	40
P37K	143.0	37.0	50	143.0	37.0	50	65.0	37.0	50	65.0	37.0	50
P45K	170.0	45.0	60				80.0	45.0	60	80.0	45.0	60
P55K							105.0	55.0	75	105.0	55.0	75
P75K							130.0	75.0	100	130.0	75.0	100
P90K							160.0	90.0	125	160.0	90.0	125
P110							190.0	110.0	150	190.0	110.0	150
P132							240.0	132.0	200	240.0	132.0	200
P160							303.0	160.0	250	303.0	160.0	250
P200							361.0	200.0	300	361.0	200.0	300
P250							443.0	250.0	350	443.0	250.0	350
P315							540.0	315.0	450	540.0	315.0	450
P355							590.0	355.0	500	590.0	355.0	500
P400							678.0	400.0	550	678.0	400.0	550
P450							730.0	450.0	600	730.0	450.0	600
P500							780.0	500.0	650	780.0	500.0	650
P560							890.0	560.0	750	890.0	560.0	750
P630							1050.0	630.0	900	1050.0	630.0	900
P710							1160.0	710.0	1000	1160.0	710.0	1000
P800							1380.0	800.0	1200	1380.0	800.0	1200
P900												
P1M0							1530.0	1000.0	1350			
P1M2												
P1M4												

Frame sizes

A	B	C	D	E
---	---	---	---	---

	3 Phase 525-600 Vac (FC 322 & FC 302)						3 Phase 525-690 Vac (FC 322 & FC 302)			
	NO 110% (FC 322)			HO 160% (FC 302)			NO 110% (FC 322)		HO 160% (FC 302)	
	Output Current Amps (575 V)	Shaft Output		Output Current Amps (575V)	Shaft Output		Output Current Amps (690 V)	Shaft Output	Output Current Amps (690 V)	Shaft Output
	KW	HP		KW	HP		KW		KW	
PK25										
PK37										
PK55										
PK75	1.7	0.75	1	1.7	0.75	1				
P1K1	2.4	1.1	1-1/2	2.4	1.1	1-1/2				
P1K5	2.7	1.5	2	2.7	1.5	2				
P2K2	3.9	2.2	3	3.9	2.2	3				
P3K0	4.9	3.0	4	4.9	3.0	4				
P3K7										
P4K0	6.1	4.0	5	6.1	4.0	5				
P5K5	9.0	5.5	7-1/2	9.0	5.5	7-1/2				
P7K5	11.0	7.5	10	11.0	7.5	10				
P11K	18.0	11.0	15	18.0	11.0	15	18.0	11.0	18.0	11.0
P15K	22.0	15.0	20	22.0	15.0	20	22.0	15.0	22.0	15.0
P18K	27.0	18.5	25	27.0	18.5	25	27.0	18.5	27.0	18.5
P22K	34.0	22.0	30	34.0	22.0	30	34.0	22.0	34.0	22.0
P30K	41.0	30.0	40	41.0	30.0	40	41.0	30.0	41.0	30.0
P37K	52.0	37.0	50	52.0	37.0	50	46.0	37.0	46.0	37.0
P45K	62.0	45.0	60	62.0	45.0	60	54.0	45.0	54.0	45.0
P55K	83.0	55.0	75	83.0	55.0	75	73.0	55.0	73.0	55.0
P75K	100.0	75.0	100	100.0	75.0	100	86.0	75.0	86.0	75.0
P90K	131.0	90.0	125				108.0	90.0	108.0	90.0
P110							131.0	110.0	131.0	110.0
P132							155.0	132.0	155.0	132.0
P160							192.0	160.0	192.0	160.0
P200							242.0	200.0	242.0	200.0
P250							290.0	250.0	290.0	250.0
P315							344.0	315.0	344.0	315.0
P355									380.0	355.0
P400							410.0	400.0	410.0	400.0
P450							450.0	450.0		
P500							500.0	500.0	500.0	500.0
P560							570.0	560.0	570.0	560.0
P630							630.0	630.0	630.0	630.0
P710							730.0	710.0	730.0	710.0
P800							850.0	800.0	850.0	800.0
P900							945.0	900.0	945.0	900.0
P1M0							1060.0	1000.0	1060.0	1000.0
P1M2							1260.0	1200.0	1260.0	1200.0
P1M4							1415.0	1400.0		

# Options & accessories

## Slot A

All options are built in and tested at the factory

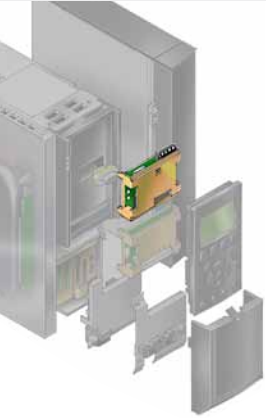

### VLT® PROFIBUS DP V1 MCA 101



Operating the frequency converter via a fieldbus lets you reduce the cost of your system, communicate faster and more efficiently, and benefit from an easier user interface

- PROFIBUS DP V1 gives you wide compatibility, a high level of availability, support for all major PLC vendors, and compatibility with future versions

- Fast, efficient communication, transparent installation, advanced diagnosis and parameter access with auto configuration of process data via GSD-file
- A-cyclic parameterization using PROFIBUS DP V1, PROFIdrive or Danfoss FC profile state machines, PROFIBUS DP V1, Master Class 1 and 2

Ordering number	VLT® AutomationVT Drive	VLT® AutomationDrive	
	FC 322	FC 301	FC 302
130B1100 uncoated 130B1200 coated	●	●	●

### VLT® DeviceNet MCA 104



DeviceNet offers robust, efficient data handling thanks to advanced producer/consumer technology.

- This modern communications model offers key capabilities that let you effectively determine what information is needed and when

- You will also benefit from ODVA's strong conformance testing policies, which ensure that products are interoperable

Ordering number	VLT® AutomationVT Drive	VLT® AutomationDrive	
	FC 322	FC 301	FC 302
130B1102 uncoated 130B1202 coated	●	●	●

### VLT® CAN Open MCA 105



High flexibility and low cost are two of the "cornerstones" for CAN Open. The CAN Open option for the AutomationDrive is fully equipped with both high priority access to control and status of the Drive (PDO Communication) and access to all parameters through acyclic data (SDO Communication).

For interoperability the option has implemented the DSP402 AC drive profile. This all guarantees standardized handling, interoperability, low cost, and seamless integration with the MCO 305 Motion Controllers bus structure for master/slave applications.

Ordering number	VLT® AutomationVT Drive	VLT® AutomationDrive	
	FC 322	FC 301	FC 302
130B1103 uncoated 130B1205 coated		●	●

### VLT® EtherNet IP MCA 121



EtherNet will become the future standard for communication at the factory floor. The EtherNet Option is based on the newest technology available for industrial use and handles even the most demanding requirements. EtherNet/IP extends commercial off-the-shelf EtherNet to the Common Industrial Protocol (CIP™)—the same upper-layer protocol and object model found in DeviceNet.

The VLT® MCA 121 offers advanced features as:

- Built-in high performance switch enabling line-topology, and eliminating the need for external switches
- Advanced switch and diagnoses functions
- Built-in web server
- E-mail client for service notification

Ordering number	VLT® AutomationVT Drive	VLT® AutomationDrive	
	FC 322	FC 301	FC 302
130B1119 uncoated 130B1219 coated	●	●	●

## Slot A

### VLT® Modbus TCP MCA 122

VLT® Modbus TCP was introduced in 1998 and is today one of the most developed, proven, and complete industrial Ethernet network solutions available for manufacturing automation.

Application protocols:

- Modbus TCP for controlling and parameter setting
- HTTP (Hypertext Transfer Protocol) for diagnosis via built-in web server

- SMTP (Simple Mail Transfer Protocol) for e-mail notification
- DHCP (Dynamic Host Configuration Protocol) automatic IP address configuration
- FTP (File Transfer Protocol) file up- and download
- TCP/IP (legacy TCP/IP) transparent Socket Channel connection to MCT 10

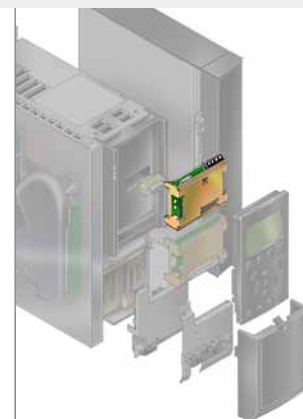

Ordering number	VLT® AutomationVT Drive	VLT® AutomationDrive	
	FC 322	FC 301	FC 302
130B1196 uncoated 130B1296 coated	●	●	●

## Slot B

### VLT® General Purpose I/O MCB 101

I/O option offers an extended number of control inputs and outputs.

- 3 digital inputs 0-24 V: Logic '0' < 5 V; Logic '1' > 10V
- 2 analog inputs 0-10 V: Resolution 10 bit plus sign

- 2 digital outputs NPN/PNP push pull
- 1 analog output 0/4-20 mA
- Spring loaded connection
- Separate parameter settings

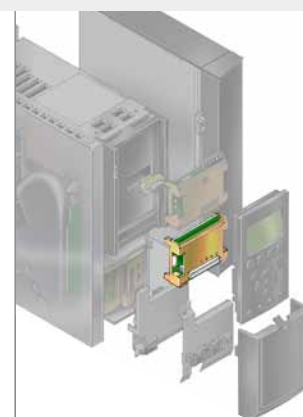

Ordering number	VLT® AutomationVT Drive	VLT® AutomationDrive	
	FC 322	FC 301	FC 302
130B1125 uncoated 130B1212 coated	●	●	●

### VLT® Encoder Input MCB 102

A universal option for connection of encoder feedback from either a motor or a process. Feedback for asynchronous or brushless servo (Permanent Magnet) motors.

- Encoder module supports:
  - Incremental encoders
  - SinCos encoders as Hyperface®

- Power supply for encoders
- RS422 interface
- Plug-and-play principle
- Fit to all FC 300 AutomationDrives
- Connection to all standard 5 V incremental encoders
- Spring-loaded connection



Ordering number	VLT® AutomationVT Drive	VLT® AutomationDrive	
	FC 322	FC 301	FC 302
130B1115 uncoated 130B1203 coated		●	●

# Options & accessories

## Slot B

All options are built in and tested at the factory

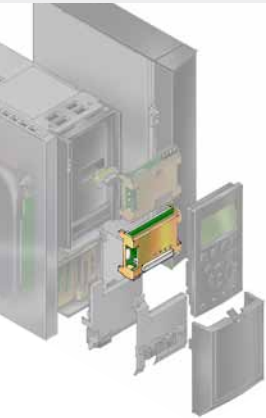

### VLT® Resolver Input MCB 103



Supports resolver feedback from brushless servo motors, and feedback for flux vector controlled asynchronous motors in rough environment.

- Primary Voltage..... 2 -8 Vrms
- Primary Frequency..... 2.0 kHz – 15 kHz

- Primary current max..... 50 mA rms
- Secondary input voltage..... 4 Vrms
- Spring loaded connection
- Separate parameter settings

Ordering number	VLT® AutomationVT Drive	VLT® AutomationDrive	
	FC 322	FC 301	FC 302
130B1127 uncoated 130B1227 coated		●	●

### VLT® Relay Option MCB 105



Lets you extend relay functions with 3 additional relay outputs.

Max. terminal load:

- AC-1 Resistive load ..... 240 V AC 2 A
- AC-15 Inductive load @cos fi 0.4 ..... 240 V AC 0.2 A
- DC-1 Resistive load ..... 24 V DC 1 A
- DC-13 Inductive load @cos fi 0.4 ..... 24 V DC 0.1 A

Min. terminal load:

- DC 5 V ..... 10 mA
- Max switch rate at rated load/min. load ..... 6 min<sup>-1</sup>/20 sec<sup>-1</sup>
- Plug-and-play principle, fits into slot B
- Protects control cable connection
- Spring-loaded control wire connection
- Selection of relay functions in normal parameter settings

Ordering number	VLT® AutomationVT Drive	VLT® AutomationDrive	
	FC 322	FC 301	FC 302
130B1110 uncoated 130B1210 coated	●	●	●

### VLT® Safe PLC I/O MCB 108



The FC 302 provides a safety input based on a single pole 24 V DC input.

- For the majority of applications this input enables the user to implement safety in a cost-effective way. For application that works with more advanced products like Safety PLC,

Lightcurtains etc., the new Safe PLC interface enables the connection of a two wire safety link

- The Safe PLC Interface allows the Safe PLC to interrupt on the plus or the minus link without interfering the sense signal of the Safe PLC

Ordering number	VLT® AutomationVT Drive	VLT® AutomationDrive	
	FC 322	FC 301	FC 302
130B1120 uncoated 130B1220 coated			●

### VLT® Analog I/O Option MCB 109



This Analog input/output option is easily fitted in the frequency converter for upgrading to advanced performance and control using the additional in/outputs. This option also upgrades the frequency converter with a battery back-up supply for the clock built into the frequency converter. This provides stable use of all frequency converter clock functions as timed actions etc.

- 3 analog inputs, each configurable as both voltage and temperature input
- Connection of 0-10 V analog signals as well as PT1000 and NI1000 temperature inputs
- 3 analog outputs each configurable as 0-10 V outputs
- Incl. Back-up supply for the standard clock function in the frequency converter

The back-up battery typically lasts for 10 years, depending on environment.

Ordering number	VLT® AutomationVT Drive	VLT® AutomationDrive	
	FC 322	FC 301	FC 302
130B1143 uncoated 130B1243 coated	●		

## VLT® PTC Thermistor Card MCB 112

With the MCB 112 PTC Thermistor Card, the Danfoss VLT® AutomationDrive FC 302 now offers improved surveillance of the motor condition compared to the built-in ETR function and thermistor terminal.

- Protects the motor from overheating
- ATEX approved for use in potentially explosive atmospheres
- Uses Safe Stop function, which is approved in accordance with Cat. 3 EN954-1

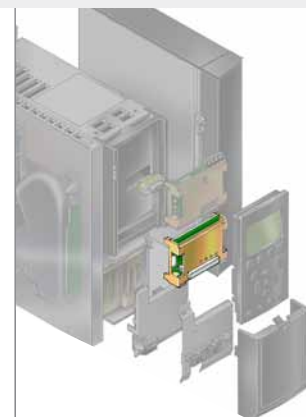

Ordering number	VLT® AutomationVT Drive	VLT® AutomationDrive	
	FC 322	FC 301	FC 302
NA uncoated 130B1137 coated			●

## VLT® Sensor Input Card MCB 114

The option protects the motor from being overheated by monitoring the bearings and windings temperature in the motor. The limits as well as the action are adjustable and the individual sensor temperature is visible as a read out in the display or by field bus.

- Protects the motor from overheating
- Three self-detecting sensor inputs for 2 or 3 wire PT100/PT1000 sensors
- One additional analog input 4-20mA



Ordering number	VLT® AutomationVT Drive	VLT® AutomationDrive	
	FC 322	FC 301	FC 302
130B1172 uncoated 130B1272 coated	●		

## VLT® Extended Cascade Controller MCO 101

Easily fitted and upgrades the built-in cascade controller to operate more pumps and more advanced pump control in master/follower mode.

- Up to 6 pumps in standard cascade setup
- Up to 5 pumps in master/follower setup
- Technical specification: See MCB 105 Relay Option



Ordering number	VLT® AutomationVT Drive	VLT® AutomationDrive	
	FC 322	FC 301	FC 302
130B1118 uncoated 130B1218 coated	●		

## USB extension

USB extension for IP 55 and IP 66 enclosures. Makes the USB connector available outside the drive. The USB extension is designed for mounting in a cable gland in the bottom of the drive, which makes PC communication very easy even in drives with high IP rating.

USB extension for A5-B1 enclosures,  
350 mm cable ..... 130B1155  
USB extension for B2-C enclosures,  
650 mm cable ..... 130B1156



Ordering number	VLT® AutomationVT Drive	VLT® AutomationDrive	
	FC 322	FC 301	FC 302
130B1155 350 mm cable	●	●	●
130B1156 650 mm cable	●	●	●

# Options & accessories

## Slot C

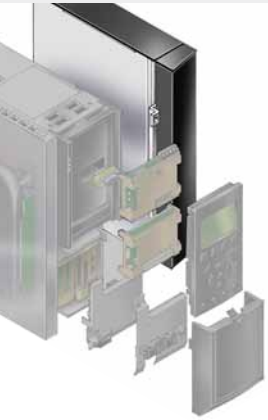

### VLT® Advanced Cascade Controller MCO 102

Easily fitted and upgrades the built-in cascade controller to operate up to 8 pumps and more advanced pump control in master/follower mode.

The same cascade controller hardware goes for the entire power range up to 1.2 MW.

- Up to 8 pumps in standard cascade setup
- Up to 8 pumps in master/follower setup

Ordering number	VLT® AutomationVT Drive	VLT® AutomationDrive	
	FC 322	FC 301	FC 302
130B1154 uncoated 130B1254 coated	●		



### VLT® Extended Relay Card MCB 113

The Extended Relay Card MCB 113 adds inputs/outputs to VLT® AutomationDrive for increased flexibility.

- 7 digital inputs
- 2 analog outputs
- 4 SPDT relays
- Meets NAMUR recommendations
- Galvanic isolation capability

Ordering number	VLT® AutomationVT Drive	VLT® AutomationDrive	
	FC 322	FC 301	FC 302
130B1164 uncoated 130B1264 coated		●	●



### VLT® Motion Control MCO 305

An integrated programmable Motion Controller for VLT® AutomationDrive FC 301 and FC 302; it adds functionality and flexibility to the already very comprehensive standard functionality of these drives.

- 2 inputs supporting both incremental and absolute encoders
- 1 encoder output (virtual master function)
- 10 digital inputs
- 8 digital outputs
- Sending and receiving data via fieldbus interface (requires fieldbus option)
- PC software tools for programming and commissioning

MCO 305 is optimized for all types of positioning and synchronizing applications.

- Basic features: Synchronization (electronic shaft), Positioning and electronic Cam control

Ordering number	VLT® AutomationVT Drive	VLT® AutomationDrive	
	FC 322	FC 301	FC 302
130B1134 uncoated 130B1234 coated		●	●



### VLT® Synchronizing Control MCO 350

The Synchronizing Controller option for VLT® AutomationDrive expands the functional properties of the converter in synchronizing applications. It replaces traditional mechanical solutions.

- Position (angle) synchronizing with or without marker correction
- On-line adjustable gear ratio
- On-line adjustable position (angle) offset
- Encoder output with virtual master function for synchronization of multiple followers
- Homing

- Display of actual synchronizing error on frequency converter control panel
- Speed synchronizing

Ordering number	VLT® AutomationVT Drive	VLT® AutomationDrive	
	FC 322	FC 301	FC 302
130B1152 uncoated 130B1252 coated		●	●

## Slot C

### VLT® Positioning Control MCO 351

The Positioning Controller option offers a host of user-friendly benefits for positioning applications in many industries. They are based on a range of thought-through and innovative features.

- Direct positioning via Fieldbus
- Relative positioning
- Absolute positioning
- Touch probe positioning

- End limit handling (software and hardware)
- Mechanical brake handling (programmable hold delay)
- Error handling
- Jog speed/manual operation
- Marker related positioning
- Home function

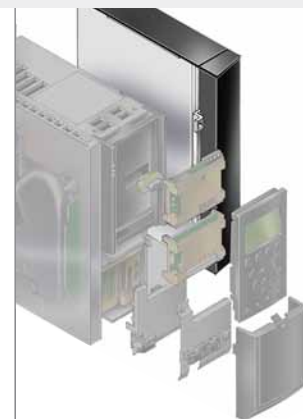

Ordering number	VLT® AutomationVT Drive	VLT® AutomationDrive	
	FC 322	FC 301	FC 302
130B1153 uncoated 130B1253 coated		●	●

### VLT® Center Winder MCO 352

With the closed loop center winder control material is evenly wound up regardless of the production speed.

- Follows line speed
- Diameter calculator adjusts winder reference
- Tension PID adjusts reference



Ordering number	VLT® AutomationVT Drive	VLT® AutomationDrive	
	FC 322	FC 301	FC 302
130B1165 uncoated 130B1266 coated		●	●

## Slot D

### VLT® 24 V DC Supply Option MCB 107

The option is used to connect an external DC supply to keep the control section and any installed option active by mains power down.

- Input voltage range .....24 V DC +/- 15% (max. 37 V in 10 sec.)
- Max. input current ..... 2.2 A

- Max. cable length ..... 75 m
- Input capacitance load ..... < 10 uF
- Power-up delay ..... < 0.6 s
- Easy to install in drives in existing machines
- Keep the control board and options active by power cut
- Keep fieldbuses active by power cuts

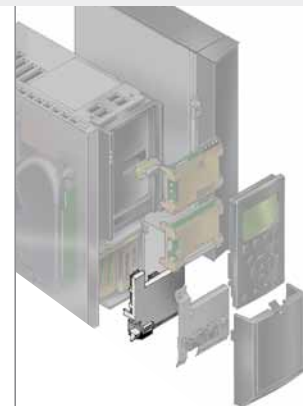

Ordering number	VLT® AutomationVT Drive	VLT® AutomationDrive	
	FC 322	FC 301	FC 302
130B1108 uncoated 130B1108 coated	●	●	●

# Options & accessories

## LCP



### LCP 102 Graphical Local Control Panel



- Multi-language display
- Status messages
- Quick menu for easy commissioning
- Parameter setting and explanation of parameter function
- Adjusting of parameters
- Full parameter backup and copy function
- Alarm logging
- Info button – explains the function of the selected item on display
- Hand-operated start/stop, or Automatic mode selection
- Reset function
- Trend graph

Ordering number	VLT® AutomationVT Drive	VLT® AutomationDrive	
	FC 322	FC 301	FC 302
130B1107	●	●	●

### LCP 101 Numerical Local Control Panel



The numerical control panel offers an excellent MMI interface to the drive.

- Status messages
- Quick menu for easy commissioning
- Parameter setting and adjusting
- Hand-operated start/stop function or Automatic mode select
- Reset function

Ordering number	VLT® AutomationVT Drive	VLT® AutomationDrive	
	FC 322	FC 301	FC 302
130B1124	●	●	●

### LCP Panel Mounting Kit



Ordering number	VLT® AutomationVT Drive	VLT® AutomationDrive	
	FC 322	FC 301	FC 302
130B1113 – Incl. graphical LCP, fasteners, 3 m cable and gasket	●	●	●
130B1114 – Incl. numerical LCP, fasteners and gasket	●	●	●
130B1117 – Mounting kit for all LCP's including fasteners, 3 m cable and gasket	●	●	●
130B1129 – LCP front mounting IP55/IP66	●	●	●
130B1170 – Panel Mounting Kit for all LCP w.o. cable	●	●	●

## Profibus Adapter Sub-D9 Connector

For use with option A

The adapter makes linking of fieldbus connections pluggable.

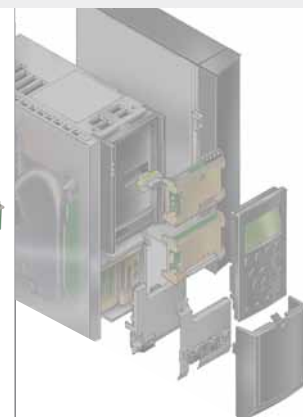

Ordering number	VLT® AutomationVT Drive	VLT® AutomationDrive	
	FC 322	FC 301	FC 302
130B1112	●	●	●

## Decoupling Plate for Fieldbus Cables

For use with option A

Strengthens fieldbus mounting.



Ordering number	VLT® AutomationVT Drive	VLT® AutomationDrive	
	FC 322	FC 301	FC 302
130B0524	●	●	●
To be used only for IP 20/NEMA type 1 units up to 7.5 kW			

## IP 21/Type 1 (NEMA1) Kit

The IP 21/Type 1 (NEMA1) kit is used for installation of VLT® drives in dry environments. The enclosure kits are available for frame sizes A1, A2, A3, B3, B4, C3 and C4

- Supports VLT® drives from 1.1 to 90 kW
- Used on standard VLT® drive with or without mounted option modules
- IP 41 on top side
- PG 16 and PG 21 holes for glands



Ordering number	VLT® AutomationVT Drive	VLT® AutomationDrive	
	FC 322	FC 301	FC 302
130B1121 For frame size A1	●	●	●
130B1122 For frame size A2	●	●	●
130B1123 For frame size A3	●	●	●
130B1187 For frame size B3	●	●	●
130B1189 For frame size B4	●	●	●
130B1191 For frame size C3	●	●	●
130B1193 For frame size C4	●	●	●

# Options & accessories

## Power Options

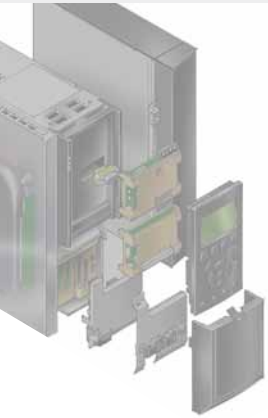

### VLT® Brake Resistors



Energy generated during braking is absorbed by the resistors, protecting electrical components from heating up. Danfoss brake resistors cover the full power range.

- Quick braking of heavy load
- Braking energy is only absorbed into the brake resistor
- External mounting makes it possible to use the generated heat
- All necessary approvals are available

Ordering number	VLT® AutomationVT Drive	VLT® AutomationDrive	
	FC 322	FC 301	FC 302
See relevant Design Guide	●	●	●

### VLT® Harmonic Filter AHF 005/010 MCE



Easy, effective harmonic distortion reduction by connecting the AHF 005/010 harmonic filter in front of a Danfoss frequency converter.

- AHF 005 reduces total harmonic current distortion to 5%
- AHF 010 reduces total harmonic current distortion to 10%

- Small compact housing that fits into a panel
- Easy to use in retrofit applications
- User-friendly start-up – no adjustment necessary
- No routine maintenance required

Ordering number	VLT® AutomationVT Drive	VLT® AutomationDrive	
	FC 322	FC 301	FC 302
See relevant Design Guide	●	●	●

### VLT® Sine-Wave Filters MCC 101



Sine-wave filters are placed between the frequency converter and the motor to optimize the motor power current. It provides a sinusoidal phase-to-phase motor voltage. The filters reduce motor insulation stress, acoustic noise from the motor, and bearing currents (especially in large motors).

- Reduce motor insulation stress
- Reduce acoustic noise from the motor
- Reduce bearing currents (especially in large motors)
- Enables use of longer motor cables
- Reduce losses in the motor
- Prolongs service lifetime

Ordering number	VLT® AutomationVT Drive	VLT® AutomationDrive	
	FC 322	FC 301	FC 302
See relevant Design Guide	●	●	●

### VLT® dV/dt filter MCC 102



VLT® dV/dt filters are placed between the frequency converter and the motor to eliminate very fast voltage changes. The motor terminal phase-to-phase voltage is still pulse shaped but its dV/dt values are reduced.

- These filters reduce stress on the motor's insulation and are recommended in applications with older motors, aggressive environments or frequent braking which cause increased DC link voltage.

Ordering number	VLT® AutomationVT Drive	VLT® AutomationDrive	
	FC 322	FC 301	FC 302
See relevant Design Guide	●	●	●

## MCT 10 (Motion Control Tools)

Offering advanced programming functionality for all Danfoss VLT® drive products, MCT 10 greatly reduces programming and commissioning times. Drives are managed in a standard folder-based user interface that's familiar and easy to understand. Parameter settings for each drive are contained in a single file, simplifying setup and the duplication of parameter sets between drives.

- SyncPos programming
- On-line and off-line commissioning
- On-board help files for each drive parameter
- Logging of alarms and warnings for improved system performance and documentation
- MCT 10 Conversion Wizards simplify drive conversion projects
- Real-time data collection using the MCT 10 Scope function
- Access to the VLT® AutomationDrive's internal data buffer, providing up to four channels of high speed (down to 1 millisc) data collection



- Simplified programming of the VLT® AutomationDrive's Smart Logic Controller using graphical programming tools
- Drive upgrade tools

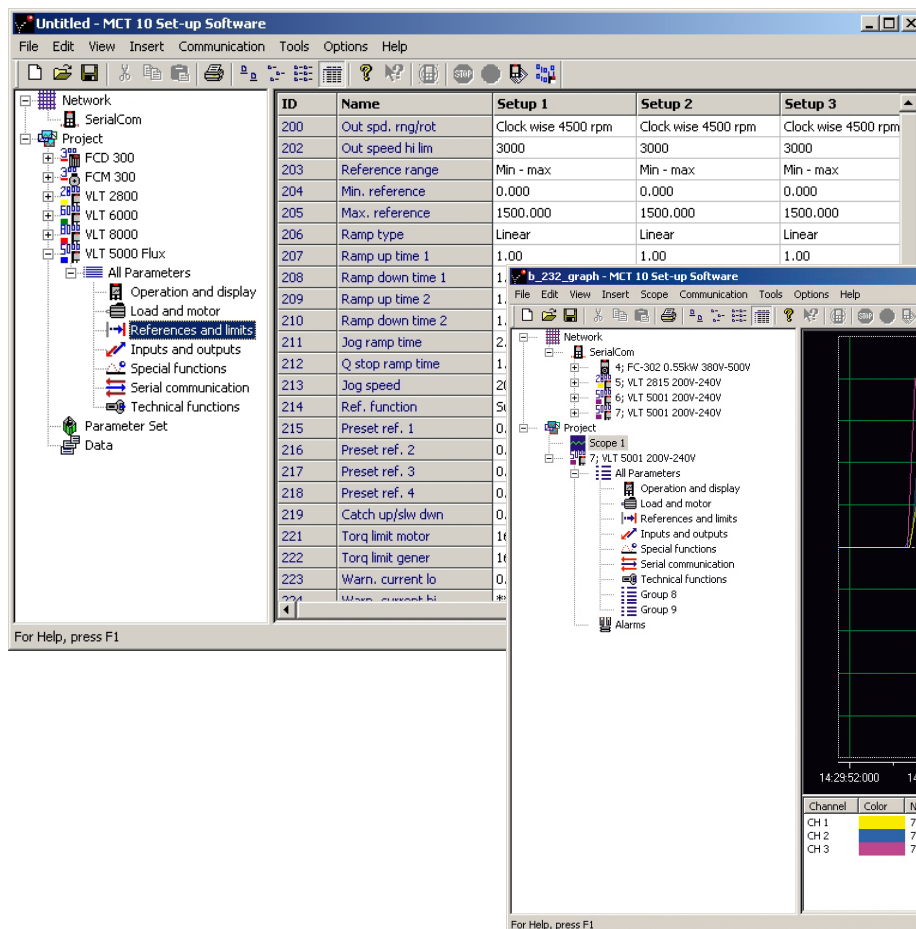

MCT 10 Basic version is available free of charge from the Danfoss web site. The Advanced edition, which offers a higher level of functionality, is available from your Danfoss sales partner.

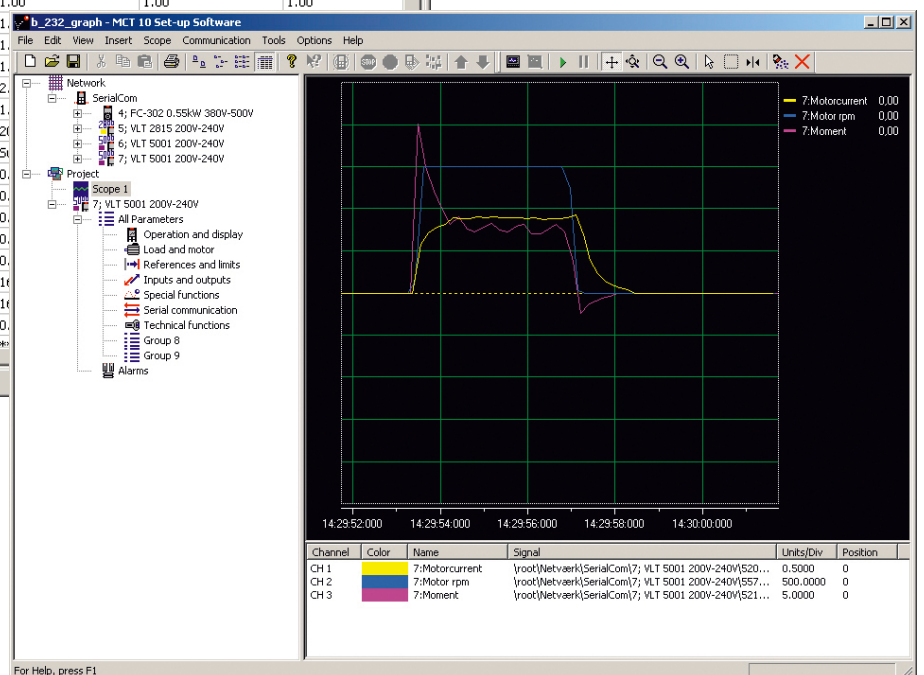

# FC 301 & FC 302 general specifications

## Mains supply:

Supply Terminals (6-Pulse)	L1, L2, L3
Supply Terminals (12-Pulse)	L1-1, L2-1, L3-1, L1-2, L2-2, L3-2
Supply voltage	200-240V ±10%
Supply voltage	FC 301: 380-480V / FC 302: 380-500V ±10%
Supply voltage	FC 302: 525-600V ±10%
Supply voltage	FC 302: 525-690V ±10%

### Mains voltage low / mains drop-out:

During low mains voltage or a mains drop-out, the FC continues until the intermediate circuit voltage drops below the minimum stop level, which corresponds typically to 15% below the frequency converter's lowest rated supply voltage. Power-up and full torque cannot be expected at mains voltage lower than 10% below the frequency converter's lowest rated supply voltage.

Supply frequency	50/60Hz ±5%
Max. imbalance temporary between mains phases	3.0 % of rated supply voltage
True Power Factor ( $\lambda$ )	≥ 0.9 nominal at rated load
Displacement Power Factor ( $\cos \phi$ )	near unity (> 0.98)
Switching on input supply L1, L2, L3 (power-ups) ≤ 7.5kW	maximum 2 times/min.
Switching on input supply L1, L2, L3 (power-ups) 11-75 kW	maximum 1 time/min.
Switching on input supply L1, L2, L3 (power-ups) ≥ 90kW	maximum 1 time/2 min.
Environment according to EN60664-1	overvoltage category III/pollution degree 2

The unit is suitable for use on a circuit capable of delivering not more than 100,000 RMS symmetrical Amperes, 240/500/600/690V maximum.

## Motor output (U, V, W):

Output voltage	0 - 100% of supply voltage
Output frequency (0.25-75kW)	FC 301: 0.2 - 1000Hz / FC 302: 0 - 1000Hz
Output frequency (90-1000kW)	0 - 800 <sup>1</sup> Hz
Output frequency in Flux Mode (FC 302 only)	0 - 300Hz
Switching on output	Unlimited
Ramp times	0.01 - 3600sec.

1) Voltage and power dependent

# FC 301 & FC 302 general specifications

## Torque characteristics:

Starting torque (Constant torque)	maximum 160% for 60 sec. <sup>1)</sup>
Starting torque	maximum 180% up to 0.5 sec. <sup>1)</sup>
Overload torque (Constant torque)	maximum 160% for 60 sec. <sup>1)</sup>
Starting torque (Variable torque)	maximum 110% for 60 sec. <sup>1)</sup>
Overload torque (Variable torque)	maximum 110% for 60 sec.

Pulse	Pause
160%/1min	91.8%/10 min
150%/1min	93.5%/10 min
110%/1min	98.9%/10 min

Table 4.1 Overload capability

Pulse	Pause
160%/60 s	0%/94 s
150%/60 s	0%/75 s
110%/60 s	0%/60 s

Table 4.2 Overload capability

Torque rise time in VVC+ (independent of fsw)	10 ms
Torque rise time in FLUX (for 5 kHz fsw)	1 ms

1) Percentage relates to the nominal torque.

2) The torque response time depends on application and load but as a general rule, the torque step from 0 to reference is 4-5 x torque rise time.

## Cable lengths and cross sections for control cables<sup>1)</sup>:

Max. motor cable length, screened	FC 301: 50m/FC 301 (A1): 25m/ FC 302: 150m
Max. motor cable length, unscreened	FC 301: 75m/FC 301 (A1): 50 m/ FC 302: 300m
Maximum cross section to control terminals, flexible/ rigid wire without cable end sleeves	1.5mm <sup>2</sup> /16 AWG
Maximum cross section to control terminals, flexible wire with cable end sleeves	1mm <sup>2</sup> /18 AWG
Maximum cross section to control terminals, flexible wire with cable end sleeves with collar	0.5mm <sup>2</sup> /20 AWG
Minimum cross section to control terminals	0.25mm <sup>2</sup> / 24AWG

1) For power cables, see electrical data tables.

## Protection and Features:

- Electronic thermal motor protection against overload.
- Temperature monitoring of the heatsink ensures that the frequency converter trips if the temperature reaches a predefined level. An overload temperature cannot be reset until the temperature of the heatsink is below the values stated in the tables on the following pages (Guideline—temperatures may vary for different power sizes, frame sizes, enclosure ratings etc.).
- The frequency converter is protected against short-circuits on motor terminals U, V, W.
- If a mains phase is missing, the frequency converter trips or issues a warning (depending on the load).
- Monitoring of the intermediate circuit voltage ensures that the frequency converter trips if the intermediate circuit voltage is too low or too high.
- The frequency converter constantly checks for critical levels of internal temperature, load current, high voltage on the intermediate circuit and low motor speeds. As a response to a critical level, the frequency converter can adjust the switching frequency and/ or change the switching pattern in order to ensure the performance of the frequency converter.

# FC 301 & FC 302 general specifications

## Digital inputs:

Programmable digital inputs	FC 301: 4 (5) <sup>1)</sup> / FC 302: 4 (6) <sup>1)</sup>
Terminal number	18, 19, 27 <sup>1)</sup> , 29 <sup>1)</sup> , 32, 33,
Logic	PNP or NPN
Voltage level	0 - 24V DC
Voltage level, logic '0' PNP	< 5V DC
Voltage level, logic '1' PNP	> 10V DC
Voltage level, logic '0' NPN <sup>2)</sup>	> 19V DC
Voltage level, logic '1' NPN <sup>2)</sup>	< 14V DC
Maximum voltage on input	28V DC
Pulse frequency range	0 - 110kHz
(Duty cycle) Min. pulse width	4.5ms
Input resistance, Ri	approx. 4 kΩ

## Safe Stop Terminal 37, <sup>3)</sup> (Terminal 37 is fixed PNP logic):

Voltage level	0 - 24V DC
Voltage level, logic '0' PNP	< 4V DC
Voltage level, logic '1' PNP	> 20V DC
Maximum voltage on input	28V DC
Typical input current at 24V	50mA rms
Typical input current at 20V	60mA rms
Input capacitance	400nF

All digital inputs are galvanically isolated from the supply voltage (PELV) and other high-voltage terminals.

1) Terminals 27 and 29 can also be programmed as output.

2) Except safe stop input Terminal 37.

3) When using a contactor with a DC coil inside in combination with Safe Stop, it is important to make a return way for the current from the coil when turning it off. This can be done by using a freewheel diode (or, alternatively, a 30 or 50V MOV for quicker response time) across the coil. Typical contactors can be bought with this diode.

## Analog inputs:

Number of analog inputs	2
Terminal number	53, 54
Modes	Voltage or current
Mode select	Switch S201 and switch S202
Voltage mode	Switch S201/switch S202 = OFF (U)
Voltage level	FC 301: 0 to + 10/ FC 302: -10 to +10V (scaleable)
Input resistance, Ri	approx. 10 kΩ
Max. voltage	± 20V
Current mode	Switch S201/switch S202 = ON (I)

# FC 301 & FC 302 general specifications

Current level	0/4 to 20 mA (scaleable)
Input resistance, Ri	approx. 200 Ω
Max. current	30 mA
Resolution for analog inputs	10 bit (+ sign)
Accuracy of analog inputs	Max. error 0.5% of full scale
Bandwidth	FC 301: 20 Hz/ FC 302: 100 Hz

The analog inputs are galvanically isolated from the supply voltage (PELV) and other high-voltage terminals.

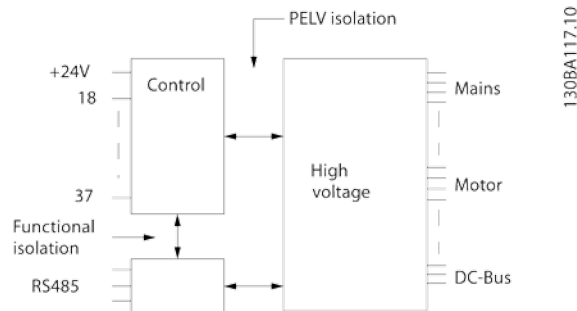

## Pulse/encoder inputs:

Programmable pulse/encoder inputs	2/1
Terminal number pulse/encoder	29 <sup>1)</sup> , 33 <sup>2)</sup> / 32 <sup>3)</sup> , 33 <sup>3)</sup>
Max. frequency at terminal 29, 32, 33	110kHz (Push-pull driven)
Max. frequency at terminal 29, 32, 33	5kHz (open collector)
Min. frequency at terminal 29, 32, 33	4Hz
Voltage level	see section on Digital input
Maximum voltage on input	28V DC
Input resistance, Ri	approx. 4kΩ
Pulse input accuracy (0.1 - 1kHz)	Max. error: 0.1% of full scale
Encoder input accuracy (1 - 11 kHz)	Max. error: 0.05 % of full scale

The pulse and encoder inputs (terminals 29, 32, 33) are galvanically isolated from the supply voltage (PELV) and other highvoltage terminals.

1) FC 302 only

2) Pulse inputs are 29 and 33

3) Encoder inputs: 32 = A, and 33 = B

# FC 301 & FC 302 general specifications

## Analog output:

Number of programmable analog outputs	1
Terminal number	42
Current range at analog output	0/4 - 20mA
Max. load GND - analog output	500Ω
Accuracy on analog output	Max. error: 0.5% of full scale
Resolution on analog output	12 bit

*The analog output is galvanically isolated from the supply voltage (PELV) and other high-voltage terminals.*

## Control card, RS-485 serial communication:

Terminal number	68 (P,TX+, RX+), 69 (N,TX-, RX-)
Terminal number 61	Common for terminals 68 and 69

*The RS-485 serial communication circuit is functionally separated from other central circuits and galvanically isolated from the supply voltage (PELV).*

## Digital output:

Programmable digital/pulse outputs	2
Terminal number	27, 29 <sup>1)</sup>
Voltage level at digital/frequency output	0 - 24V
Max. output current (sink or source)	40mA
Max. load at frequency output	1kΩ
Max. capacitive load at frequency output	10nF
Minimum output frequency at frequency output	0Hz
Maximum output frequency at frequency output	32kHz
Accuracy of frequency output	Max. error: 0.1 % of full scale
Resolution of frequency outputs	12 bit

*1) Terminal 27 and 29 can also be programmed as input. The digital output is galvanically isolated from the supply voltage (PELV) and other high-voltage terminals.*

## Control card, 24V DC output:

Terminal number	12, 13
Output voltage	24V +1, -3V
Max. load	FC 301: 130mA/ FC 302: 200mA

*The 24V DC supply is galvanically isolated from the supply voltage (PELV), but has the same potential as the analog and digital inputs and outputs.*

# FC 301 & FC 302 general specifications

## Relay outputs:

Programmable relay outputs	FC 301 all kW: 1 / FC 302 all kW: 2
Relay 01 Terminal number	1-3 (break), 1-2 (make)
Max. terminal load (AC-1) <sup>1)</sup> on 1-3 (NC), 1-2 (NO) (Resistive load)	240V AC, 2A
Max. terminal load (AC-15) <sup>1)</sup> (Inductive load @ cosφ 0.4)	240V AC, 0.2A
Max. terminal load (DC-1) <sup>1)</sup> on 1-2 (NO), 1-3 (NC) (Resistive load)	60V DC, 1A
Max. terminal load (DC-13) <sup>1)</sup> (Inductive load)	24V DC, 0.1A
Relay 02 (FC 302 only) Terminal number	4-6 (break), 4-5 (make)
Max. terminal load (AC-1) <sup>1)</sup> on 4-5 (NO) (Resistive load) <sup>2)3)</sup> Overvoltage cat. II	400V AC, 2A
Max. terminal load (AC-15) <sup>1)</sup> on 4-5 (NO) (Inductive load @ cosφ 0.4)	240V AC, 0.2A
Max. terminal load (DC-1) <sup>1)</sup> on 4-5 (NO) (Resistive load)	80V DC, 2A
Max. terminal load (DC-13) <sup>1)</sup> on 4-5 (NO) (Inductive load)	24V DC, 0.1A
Max. terminal load (AC-1) <sup>1)</sup> on 4-6 (NC) (Resistive load)	240V AC, 2A
Max. terminal load (AC-15) <sup>1)</sup> on 4-6 (NC) (Inductive load @ cosφ 0.4)	240V AC, 0.2A
Max. terminal load (DC-1) <sup>1)</sup> on 4-6 (NC) (Resistive load)	50V DC, 2A
Max. terminal load (DC-13) <sup>1)</sup> on 4-6 (NC) (Inductive load)	24V DC, 0.1A
Min. terminal load on 1-3 (NC), 1-2 (NO), 4-6 (NC), 4-5 (NO)	24V DC 10mA, 24V AC 20mA
Environment according to EN 60664-1	overvoltage category III/pollution degree 2

1) IEC 60947 part 4 and 5

The relay contacts are galvanically isolated from the rest of the circuit by reinforced isolation (PELV).

2) Overvoltage Category II

3) UL applications 300V AC2A

## Control card, 10V DC output:

Terminal number	50
Output voltage	10.5V ±0.5V
Max. load	15mA

The 10V DC supply is galvanically isolated from the supply voltage (PELV) and other high-voltage terminals.

## Control characteristics:

Resolution of output frequency at 0 - 1000Hz	± 0.003Hz
Repeat accuracy of Precise start/stop (terminals 18, 19)	≤± 0.1ms
System response time (terminals 18, 19, 27, 29, 32, 33)	≤ 2ms
Speed control range (open loop)	1:100 of synchronous speed
Speed control range (closed loop)	1:1000 of synchronous speed
Speed accuracy (open loop)	30 - 4000rpm: error ±8rpm
Speed accuracy (closed loop), depending on resolution of feedback device	0 - 6000rpm: error ±0.15rpm
Torque control accuracy (speed feedback)	max error ±5% of rated torque

All control characteristics are based on a 4-pole asynchronous motor

# FC 301 & FC 302 general specifications

## Control card performance:

Scan interval	FC 301: 5 ms / FC 302: 1 ms
---------------	-----------------------------

## Surroundings:

Frame size A1, A2, A3 and A5	IP 20, IP 55, IP 66
Frame size B1, B2, C1 and C2	IP 21, IP 55, IP 66
Frame size B3, B4, C3 and C4	IP 20
Frame size D1, D2, E1, F1, F2, F3 and F4	IP 21, IP 54
Frame size D3, D4 and E2	IP 00
Enclosure kit available $\leq$ 7.5 kW	IP21/TYPE 1/IP 4X top
Vibration test, frame size A, B and C	1.0 g RMS
Vibration test, frame size D, E and F	1 g
Max. relative humidity	5% - 95%(IEC 60 721-3-3; Class 3K3 (non-condensing) during operation
Aggressive environment (IEC 60068-2-43) H2S test	class Kd
Test method according to IEC 60068-2-43 H2S (10 days)	
Ambient temperature, frame size A, B and C	Max. 50 °C
Ambient temperature, frame size D, E and F	Max. 45 °C
<i>Derating for high ambient temperature, see section on special conditions</i>	
Minimum ambient temperature during full-scale operation	0 °C
Minimum ambient temperature at reduced performance	- 10 °C
Temperature during storage/transport	-25 - +65/70 °C
Maximum altitude above sea level	1000 m
<i>Derating for high altitude, see section on special conditions</i>	
EMC standards, Emission	EN 61800-3, EN 61000-6-3/4, EN 55011
EMC standards, Immunity	EN 61800-3, EN 61000-6-1/2, EN 61000-4-2, EN 61000-4-3, EN 61000-4-4, EN 61000-4-5, EN 61000-4-6

## Control card, USB serial communication:

USB standard	1.1 (Full speed)
USB plug	USB type B "device" plug

Connection to PC is carried out via a standard host/device USB cable.

The USB connection is galvanically isolated from the supply voltage (PELV) and other high-voltage terminals.

The USB ground connection is not galvanically isolated from protection earth. Use only an isolated laptop as PC connection to the USB connector on the frequency converter.

# FC 322 general specifications

## Protection and Features:

- Electronic thermal motor protection against overload.
- Temperature monitoring of the heatsink ensures that the frequency converter trips if the temperature reaches  $95\text{ °C} \pm 5\text{ °C}$ . An overload temperature cannot be reset until the temperature of the heatsink is below  $70\text{ °C} \pm 5\text{ °C}$  (Guideline - these temperatures may vary for different power sizes, enclosures etc.). VLT Automation VT Drive Drive has an auto derating function to avoid it's heatsink reaching  $95\text{ °C}$ .
- The frequency converter is protected against short-circuits on motor terminals U, V, W.
- If a mains phase is missing, the frequency converter trips or issues a warning (depending on the load).
- Monitoring of the intermediate circuit voltage ensures that the frequency converter trips if the intermediate circuit voltage is too low or too high.
- The frequency converter is protected against earth faults on motor terminals U, V, W.

## Mains supply (L1, L2, L3):

Supply voltage	200-240 V $\pm 10\%$
Supply voltage	380-480 V $\pm 10\%$
Supply voltage	525-600 V $\pm 10\%$
Supply voltage	525-690 V $\pm 10\%$

*Mains voltage low / mains drop-out:*

*During low mains voltage or a mains drop-out, the FC continues until the intermediate circuit voltage drops below the minimum stop level, which corresponds typically to 15% below the FC's lowest rated supply voltage. Power-up and full torque cannot be expected at mains voltage lower than 10% below the FC's lowest rated supply voltage.*

Supply frequency	50/60 Hz $+4/-6\%$
------------------	--------------------

*The frequency converter power supply is tested in accordance with IEC61000-4-28, 50 Hz  $+4/-6\%$ .*

Max. imbalance temporary between mains phases	3.0 % of rated supply voltage
True Power Factor ()	$\geq 0.9$ nominal at rated load
Displacement Power Factor (cos) near unity	(> 0.98)
Switching on input supply L1, L2, L3 (power-ups) $\leq$ enclosure type A	maximum 2 times/min.
Switching on input supply L1, L2, L3 (power-ups) $\geq$ enclosure type B, C	maximum 1 time/min.
Switching on input supply L1, L2, L3 (power-ups) $\geq$ enclosure type D, E, F	maximum 1 time/2 min.
Environment according to EN60664-1	overvoltage category III/pollution degree 2

*The unit is suitable for use on a circuit capable of delivering not more than 100.000 RMS symmetrical Amperes, 240/480 V maximum.*

## Motor output (U, V, W):

Output voltage	0 - 100% of supply voltage
Output frequency	0 - 1000 Hz*
Switching on output	Unlimited
Ramp times	1 - 3600 sec.

*\* Dependent on power size.*

# FC 322 general specifications

## Torque characteristics:

Starting torque (Constant torque)	maximum 110% for 1 min.*
Starting torque	maximum 135% up to 0.5 sec.*
Overload torque (Constant torque)	maximum 110% for 1 min.*

\*Percentage relates to VLT AutomationVT Drive's nominal torque.

## Cable lengths and cross sections:

Max. motor cable length, screened/armoured	VLT AutomationVT Drive: 150 m
Max. motor cable length, unscreened/unarmoured	VLT AutomationVT Drive: 300 m
Max. cross section to motor, mains, load sharing and brake *	
Maximum cross section to control terminals, rigid wire	1.5 mm <sup>2</sup> /16 AWG (2 x 0.75 mm <sup>2</sup> )
Maximum cross section to control terminals, flexible cable	1 mm <sup>2</sup> /18 AWG
Maximum cross section to control terminals, cable with enclosed core	0.5 mm <sup>2</sup> /20 AWG
Minimum cross section to control terminals	0.25 mm <sup>2</sup>

## Control card, RS-485 serial communication:

Terminal number	68 (P,TX+, RX+), 69 (N,TX-, RX-)
Terminal number 61	Common for terminals 68 and 69

The RS-485 serial communication circuit is functionally separated from other central circuits and galvanically isolated from the supply voltage (PELV).

## Analog inputs:

Number of analog inputs	2
Terminal number	53, 54
Modes	Voltage or current
Mode select	Switch S201 and switch S202
Voltage mode	Switch S201/switch S202 = OFF (U)
Voltage level	: 0 to + 10 V (scaleable)
Input resistance, Ri	approx. 10 k<?>
Max. voltage	± 20 V
Current mode	Switch S201/switch S202 = ON (I)
Current level	0/4 to 20 mA (scaleable)
Input resistance, Ri	approx. 200 <?>
Max. current	30 mA
Resolution for analog inputs	10 bit (+ sign)
Accuracy of analog inputs	Max. error 0.5% of full scale
Bandwidth	: 200 Hz

The analog inputs are galvanically isolated from the supply voltage (PELV) and other high-voltage terminals.

# FC 322 general specifications

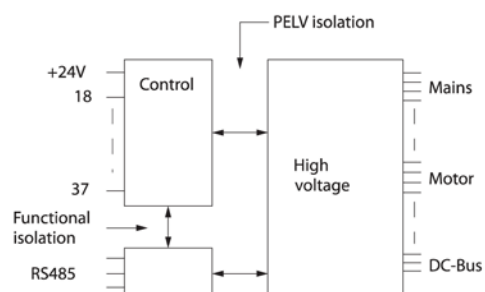

## Analog output:

Number of programmable analog outputs	1
Terminal number	42
Current range at analog output	0/4 - 20 mA
Max. resistor load to common at analog output	500 <?>
Accuracy on analog output Max. error	: 0.8 % of full scale
Resolution on analog output	8 bit

The analog output is galvanically isolated from the supply voltage (PELV) and other high-voltage terminals.

## Digital inputs:

Programmable digital inputs	4 (6)
Terminal number	18, 19, 27 <sup>1)</sup> , 29 <sup>1)</sup> , 32, 33,
Logic	PNP or NPN
Voltage level	0 - 24 V DC
Voltage level, logic '0' PNP	< 5 V DC
Voltage level, logic '1' PNP	> 10 V DC
Voltage level, logic '0' NPN	> 19 V DC
Voltage level, logic '1' NPN	< 14 V DC
Maximum voltage on input	28 V DC
Input resistance, Ri	approx. 4 k

All digital inputs are galvanically isolated from the supply voltage (PELV) and other high-voltage terminals.

1) Terminals 27 and 29 can also be programmed as output.

## Digital output:

Programmable digital/pulse outputs	2
Terminal number	27, 29 <sup>1)</sup>
Voltage level at digital/frequency output	0 - 24 V
Max. output current (sink or source)	40 mA
Max. load at frequency output	1 k<?>

# FC 322 general specifications

Max. capacitive load at frequency output	10 nF
Minimum output frequency at frequency output	0 Hz
Maximum output frequency at frequency output	32 kHz
Accuracy of frequency output	Max. error: 0.1 % of full scale
Resolution of frequency outputs	12 bit

1) Terminal 27 and 29 can also be programmed as input.

The digital output is galvanically isolated from the supply voltage (PELV) and other high-voltage terminals.

## Pulse inputs:

Programmable pulse inputs	2
Terminal number pulse	29, 33
Max. frequency at terminal, 29, 33	110 kHz (Push-pull driven)
Max. frequency at terminal, 29, 33	5 kHz (open collector)
Min. frequency at terminal 29, 33	4 Hz
Voltage level	see section on Digital input
Maximum voltage on input	28 V DC
Input resistance, Ri	approx. 4 k $\Omega$
Pulse input accuracy (0.1 - 1 kHz)	Max. error: 0.1% of full scale

## Control card, 24 V DC output:

Terminal number	12, 13
Max. load	: 200 mA

The 24 V DC supply is galvanically isolated from the supply voltage (PELV), but has the same potential as the analog and digital inputs and outputs.

## Relay outputs:

Programmable relay outputs	2
<b>Relay 01 Terminal number</b>	1-3 (break), 1-2 (make)
Max. terminal load (AC-1) <sup>1)</sup> on 1-3 (NC), 1-2 (NO) (Resistive load)	240 V AC, 2 A
Max. terminal load (AC-15) <sup>1)</sup> (Inductive load @ cos 0.4)	240 V AC, 0.2 A
Max. terminal load (DC-1) <sup>1)</sup> on 1-2 (NO), 1-3 (NC) (Resistive load)	60 V DC, 1A
Max. terminal load (DC-13) <sup>1)</sup> (Inductive load)	24 V DC, 0.1A
<b>Relay 02 Terminal number</b>	4-6 (break), 4-5 (make)
Max. terminal load (AC-1) <sup>1)</sup> on 4-5 (NO) (Resistive load) <sup>2)3)</sup>	400 V AC, 2 A
Max. terminal load (AC-15) <sup>1)</sup> on 4-5 (NO) (Inductive load @ cos 0.4)	240 V AC, 0.2 A
Max. terminal load (DC-1) <sup>1)</sup> on 4-5 (NO) (Resistive load)	80 V DC, 2 A
Max. terminal load (DC-13) <sup>1)</sup> on 4-5 (NO) (Inductive load)	24 V DC, 0.1A
Max. terminal load (AC-1) <sup>1)</sup> on 4-6 (NC) (Resistive load)	240 V AC, 2 A

# FC 322 general specifications

Max. terminal load (AC-15) <sup>1)</sup> on 4-6 (NC) (Inductive load @ cos 0.4)	240 V AC, 0.2A
Max. terminal load (DC-1) <sup>1)</sup> on 4-6 (NC) (Resistive load)	50 V DC, 2 A
Max. terminal load (DC-13) <sup>1)</sup> on 4-6 (NC) (Inductive load)	24 V DC, 0.1 A
Min. terminal load on 1-3 (NC), 1-2 (NO), 4-6 (NC), 4-5 (NO)	24 V DC 10 mA, 24 V AC 20 mA
Environment according to EN 60664-1	overvoltage category III/pollution degree 2

1) IEC 60947 part 4 and 5

The relay contacts are galvanically isolated from the rest of the circuit by reinforced isolation (PELV).

2) Overvoltage Category II

3) UL applications 300 V AC 2A

## Control card, 10 V DC output:

Terminal number	50
Output voltage	10.5 V ±0.5 V
Max. load	25 mA

The 10 V DC supply is galvanically isolated from the supply voltage (PELV) and other high-voltage terminals.

## Control characteristics:

Resolution of output frequency at 0 - 1000 Hz	: +/- 0.003 Hz
System response time (terminals 18, 19, 27, 29, 32, 33)	: ≤ 2 ms
Speed control range (open loop)	1:100 of synchronous speed
Speed accuracy (open loop)	30 - 4000 rpm: Maximum error of ±8 rpm

All control characteristics are based on a 4-pole asynchronous motor

## Surroundings:

Enclosure type A	IP 20/Chassis, IP 21kit/Type 1, IP55/Type12, IP 66
Enclosure type B1/B2	IP 21/Type 1, IP55/Type12, IP 66
Enclosure type B3/B4	IP20/Chassis
Enclosure type C1/C2	IP 21/Type 1, IP55/Type 12, IP66
Enclosure type C3/C4	IP20/Chassis
Enclosure type D1/D2/E1	IP21/Type 1, IP54/Type12
Enclosure type D3/D4/E2	IP00/Chassis
Enclosure kit available ≤ enclosure type A	IP21/TYPE 1/IP 4X top
Vibration test enclosure A/B/C	1.0 g
Vibration test enclosure D/E/F	0.7 g
Max. relative humidity	5% - 95%(IEC 721-3-3; Class 3K3 (non-condensing) during operation
Aggressive environment (IEC 721-3-3), uncoated	class 3C2
Aggressive environment (IEC 721-3-3), coated	class 3C3
Test method according to IEC 60068-2-43 H2S (10 days)	
Ambient temperature	Max. 50 °C

Derating for high ambient temperature, see section on special conditions

# FC 322 general specifications

Minimum ambient temperature during full-scale operation	0 °C
Minimum ambient temperature at reduced performance	- 10 °C
Temperature during storage/transport	-25 - +65/70 °C
Maximum altitude above sea level without derating	1000 m
Maximum altitude above sea level with derating	3000 m
<i>Derating for high altitude, see section on special conditions</i>	
EMC standards, Emission	EN 61800-3, EN 61000-6-3/4, EN 55011, IEC 61800-3
EMC standards, Immunity	EN 61800-3, EN 61000-6-1/2, EN 61000-4-2, EN 61000-4-3, EN 61000-4-4, EN 61000-4-5, EN 61000-4-6

## Control card performance:

Scan interval	: 5 ms
---------------	--------

## Control card, USB serial communication:

USB standard	1.1 (Full speed)
USB plug	USB type B "device" plug



Connection to PC is carried out via a standard host/device USB cable.

The USB connection is galvanically isolated from the supply voltage (PELV) and other high-voltage terminals.

The USB connection is not galvanically isolated from protection earth. Use only isolated laptop/PC as connection to the USB connector on VLT Automation VT Drive or an isolated USB cable/converter.

# Ordering type code for VLT® AutomationDrives

[1] [2] [3] [4] [5] [6] [7] [8] [9] [10] [11] [12] [13] [14] [15] [16] [17] [18]

FC [ ] - [ ] - [ ] - [ ] - [ ] - [ ] - [ ] - [ ] - [ ] - X - X - SXXX - [ ] - [ ] - [ ] - [ ] - [ ] - [ ] - [ ]

## [1] Application

301	VLT® AutomationDrive FC 301
302	VLT® AutomationDrive FC 302
322	VLT® AutomationVT Drive FC 322

## [2] Power Size

PK25	1/3 HP 0.25 KW
P1M4	1400 KW
See pages 14 and 15 for complete list of power sizes available by voltage.	

## [3] AC Line Voltage

T2	3Ø 200 - 240 VAC
T4	3Ø 380 - 480 VAC (FC 322)
T5	3Ø 380 - 500 VAC (FC 302)
T6	3Ø 525 - 600 VAC (FC 302)
T7	3Ø 525 - 690 VAC

## [4] Enclosure

For cabinet mounting:	
E00	IP00 (enclosure D3, D4)
Z20	IP20 (enclosure A1, FC 301 only)
E20	IP20 (enclosure A2, A3, B3, B4, C3, C4)
Standalone:	
E21	IP21 NEMA 1 (enclosure B1, B2, C1, C2, D1, D2)
E54	IP54 NEMA 12 (enclosure D1, D2)
E55	IP55 (enclosure D1, D2)
E66	IP66 (enclosure A5, B1, B2, C1, C2)
Special design:	
C00	IP00 (enclosure E00–air duct in stainless steel)
P20	IP20 (enclosure B4, C3, C4–rear heat sink)
E2M	IP21 (enclosure D1, D2,–protective cover)
P21	IP21 (enclosure as E21–rear heat sink)
E5M	IP54 (enclosure D1, D2,–protective cover)
P55	IP55 (enclosure as E55–rear heat sink)

## [5] RFI filter

H1	RFI-Filter Class A1/B
H2	INo RFI-Filter, Class A2
H3	RFI-Filter Class A1
H4	RFI-Filter, Class A1
H6	RFI-Filter for Marine
HE	Integral Class A2 filter with residual current monitor
HX	No RFI-Filter (only 600V)

## [6] Braking & Safety

X	No brake IGBT
B	Brake IGBT mounted
R	Regen Terminals
T	Safe stop without brake
U	With brake and safe stop

## [7] Display (Local Control Panel)

X	Blank faceplate, no LCP installed
G	LCP 102 – Numeric LCP installed
N	LCP 101 – Graphic LCP installed

## [8] Conformal Coating

X	No conformal coating
C	Conformal coating on all PCBs

## [9] Mains Input

X	No option
1	Mains disconnect
3	Mains disconnect & fuses
5	Mains disconnect, fuses and loadsharing
7	Fuses
8	Mains disconnect and load sharing
A	Fuses & load sharing terminals
D	Load sharing terminals

## [12] LCP Language Pack

X	Standard language pack
---	------------------------

## [13] Fieldbus

AX	No Fieldbus Option Installed
A0	Profibus MCA101 Option Card
A4	DeviceNet MCA104 Option Card
A6	CAN Open MCA105 Option Card
AN	Ethernet IP MCA121 Option Card
AQ	Modbus TCP/IP MCA122 Option Card

## [14] Application Option

BX	No application option
B2	PTC Thermistor Input MCB112 Option Card (FC-302 Only)
BK	General Purpose I/O MCB101 Option Card
BO	Analog I/O plus Battery Backup MCB109 (FC 322 Only)
BP	Relay Expansion MCB105 Option Card
BR	Encoder Input MCB102 Option Card
BU	Resolver Input MCB103 Option Card
BY	Extended Cascade Control MCO101 (FC 322 Only)
BZ	SAFE PLC Interface MCB108 Option Card

## [15] Motion Control

CX	No motion control option
C4	Motion Control MCO 305 Option Card

## [16] Motion Control Output

X	No motion control output option
5	Advanced Cascade Control MCO 102 (FC 322 Only)
R	Extended Relay MCB 113 Option Card (FC 302 Only)

## [17] Motion Control Software

XX	No Motion Control Software <i>Note: C4 option in [15] selected with no motion software in [17] will require programming by a qualified individual</i>
10	Software for Synchronizing Control MCO 350*
11	Software for Positioning Control MCO 351*
12	Software for Center Winding MCO 352*
15	Software for SALT MCO 360* <i>* Must select C4 in block [15]</i>

## [18] Voltage Input

DX	No DC Input Option Installed
D0	24 Vdc MCB 107 Option Card

*Not all combinations are valid. Consult your Danfoss Representative for valid combinations.*

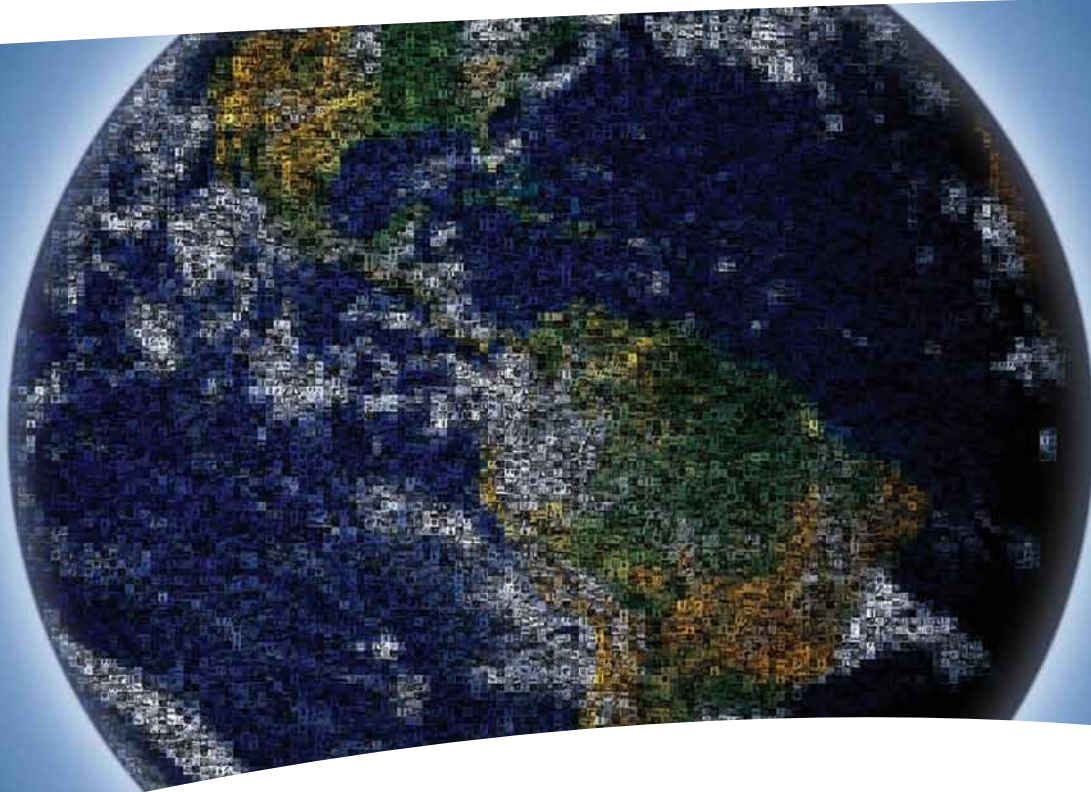

## EnVisioneering

As a world leader in components and solutions, Danfoss meets our customers' challenges through "EnVisioneering." This approach expresses our views on engineering innovation, energy efficiency, environmental responsibility and sustainable business growth that create strong customer partnerships. This vision is realized through a global production, sales, and service network focused on refrigeration, air conditioning, heating and water, and motion control. Through EnVisioneering, Danfoss is Making Modern Living Possible.

Danfoss "EnVisioneering":

- Engineered solutions to improve performance and profitability
- Energy efficiency to meet higher standards and to lower operating costs
- Environmental sustainability to provide a financial and social payback
- Engaged partnerships to foster trust, reliability, and technological superiority

---

Danfoss can accept no responsibility for possible errors in catalogs, brochures and other printed material. Danfoss reserves the right to alter its products without notice. This also applies to products already on order provided that such alterations can be made without subsequent changes being necessary in specifications already agreed. All trademarks in this material are property of the respective companies. Danfoss and the Danfoss logotype are trademarks of Danfoss A/S. All rights reserved.

---